

Sonnenschein Lithium Batteries

Product
Data
Catalogue



Product List



Keyword	Size	Type Designation/ Termination	Nominal Capacity	Nominal Current	Max. Cont. Discharge Current	Temperature Range	Catalogue Number	Page
Standard Use and Stand-By	BEL	SL-340	0.40 Ah	0.3 mA	3 mA	-55°C...+75°C	11 1 13404 00	6
	1/10D	SL-389	1.00 Ah	1 mA	10 mA	-55°C...+75°C	11 1 13894 00	7
	1/6D	SL-386	1.70 Ah	1 mA	10 mA	-55°C...+75°C	11 1 03864 00	8
	1/2AA	SL-350/S SL-350/T SL-350/P SL-350/PR SL-350/PT	1.00 Ah	0.6 mA	6 mA	-55°C...+85°C	11 1 03501 00	9
							11 1 03502 00	
							11 1 03503 00	
							11 1 03506 00	
							11 1 03508 00	
	2/3AA	SL-361/S SL-361/T SL-361/P SL-361/PR SL-361/PT	1.45 Ah	1 mA	10 mA	-55°C...+85°C	11 1 03611 00	10
							11 1 03612 00	
							11 1 03613 00	
							11 1 03616 00	
							11 1 03618 00	
	AA	SL-360/S SL-360/T SL-360/P SL-360/PR SL-360/PT	2.30 Ah	2 mA	20 mA	-55°C...+85°C	11 1 03601 00	11
							11 1 03602 00	
							11 1 03603 00	
							11 1 03606 00	
							11 1 03608 00	
Extended Temperature Range	1/2AA	SL-550/S SL-550/T SL-550/P SL-550/PR SL-550/PT	0.80 Ah	0.6 mA	6 mA	-55°C...+130°C	11 1 05501 00	12
							11 1 05502 00	
							11 1 05503 00	
							11 1 05506 00	
							11 1 05508 00	
	2/3AA	SL-561/S SL-561/T SL-561/P SL-561/PR SL-561/PT	1.00 Ah	1 mA	10 mA	-55°C...+130°C	11 1 05611 00	13
							11 1 05612 00	
							11 1 05613 00	
							11 1 05616 00	
							11 1 05618 00	
	AA	SL-560/S SL-560/T SL-560/P SL-560/PR SL-560/PT	1.70 Ah	2 mA	20 mA	-55°C...+130°C	11 1 05601 00	14
							11 1 05602 00	
Enhanced Start	BEL	SL-740	0.37 Ah	0.3 mA	3 mA	-55°C...+75°C	11 1 17404 00	15
	1/10D	SL-789	0.95 Ah	1 mA	10 mA	-55°C...+75°C	11 1 17894 00	16
	1/6D	SL-786	1.60 Ah	1 mA	10 mA	-55°C...+75°C	11 1 17864 00	17
	1/2AA	SL-750/S SL-750/T SL-750/P SL-750/PR SL-750/PT	0.95 Ah	0.6 mA	20 mA	-55°C...+85°C	11 1 07501 00	18
							11 1 07502 00	
							11 1 07503 00	
							11 1 07506 00	
							11 1 07508 00	
	2/3AA	SL-761/S SL-761/T SL-761/P SL-761/PR SL-761/PT	1.35 Ah	1 mA	30 mA	-55°C...+85°C	11 1 07611 00	19
							11 1 07612 00	
							11 1 07613 00	
							11 1 07616 00	
							11 1 07618 00	
	AA	SL-760/S SL-760/T SL-760/P SL-760/PR SL-760/PT	2.10 Ah	2 mA	60 mA	-55°C...+85°C	11 1 07601 00	20
							11 1 07602 00	
							11 1 07603 00	
							11 1 07606 00	
							11 1 07608 00	
	C	SL-770/S SL-770/T SL-770/P	7.20 Ah	3 mA	100 mA	-55°C...+85°C	11 1 17701 00	21
							11 1 17702 00	
							11 1 17703 00	
D	SL-780/S SL-780/T SL-780/P	16.50 Ah	6 mA	200 mA	-55°C...+85°C	11 1 17801 00	22	
						11 1 17802 00		
						11 1 17803 00		
DD	SL-790/S SL-790/T	35.00 Ah	10 mA	300 mA	-55°C...+85°C	11 1 17901 00	23	
						11 1 17902 00		
Computer Batteries		SL-360/461	2.10 Ah	2 mA	20 mA	-55°C...+85°C	14 1 6360 461	24
		SL-360/486	1.90 Ah	0.2 mA	0.2 mA	-55°C...+85°C	14 2 6360 486	25

Sonnenschein Lithium
Product Data Catalogue

Sonnenschein Lithium GmbH

Sonnenschein Lithium was founded in 1984, with plant facilities at Büdingen near Frankfurt, Germany. The creation of the company was preceded by transfer of knowledge from prestigious partner firms and several years of market experience as their distributor. Today, the company is the leading manufacturer in the European market for lithium thionyl chloride batteries.

Research and Development has been a decisive factor in establishing the company's leadership position. Environment-friendly manufacturing processes, continuous improvement and constant enhancement of the battery system as well as the specialization in lithium batteries help to strengthen the competitive edge of Sonnenschein Lithium's customers in their respective markets and ensure the availability of reliable power supplies for their electronic products, today and in the future.

Sonnenschein Lithium was one of the first battery manufacturers to obtain ISO 9001 certification of the quality management system in 1993.

Close co-operation with our customers during the design phase is part of the company's basic philosophy. Sonnenschein Lithium offers comprehensive support from experienced specialists, and is committed to securing its position as a market leader and a competent, reliable technology partner.

The Lithium/Thionyl Chloride Battery

The Sonnenschein lithium/thionyl chloride inorganic electrolyte battery is a power source that is suited to the requirements of the new generation in microelectronics. For example, CMOS memories as well as utility meters require a lightweight power source to provide a safe and reliable performance over a wide range of environmental conditions, for long periods of time.

The Sonnenschein Lithium battery is a component that can be permanently connected to a circuit and, in many cases, will last the entire lifetime of the equipment.

Battery Characteristics

The major advantages of the Sonnenschein Lithium battery are:

High cell voltage.

The battery has a nominal voltage of 3.6 Volts, which is considerably higher than any other commercially available primary cell.

Wide temperature range.

The batteries are capable of operating in a wide temperature range normally from -55°C to $+85^{\circ}\text{C}$. One series, however, has an extended temperature range of up to 130°C .

High Energy Density.

The electrochemical system offers the highest energy density of any available primary battery: up to 650 Wh/kg and 1280 Wh/dm³.

Superior shelf life and reliability.

The Sonnenschein lithium battery has an outstandingly long shelf life. Tests have shown that storage for ten years at room temperature results in a capacity loss of less than 1% per year.

Sonnenschein lithium batteries are also extremely reliable and failure rates in memory back-up applications were found to be below 200 FIT (FIT: Failures in Time. 1 FIT = 1 failure in 10⁹ component hours)

Safe design.

The battery's design has a major influence on its safety characteristics.

In the bobbin version, the cathode is cylindrical in shape. The anode is swaged against the inner wall of the battery case. This offers several advantages in terms of safety. In the event of an unintentional short-circuit, the discharge currents do not become very strong. The heat generated, primarily at the contact surface between the anode and cathode, can easily be channelled to the outside. This design leads to a safe battery that needs no additional rupture vent.

In the flat battery versions, the anode is pressed onto the bottom of the case, and the cathode is disk-shaped. Flat batteries are wider than they are high. They are just as safe as the bobbin type batteries.

Hermetically sealed case.

The hermetically sealed case is essential for the long shelf life and inherent safety of the devices in which the batteries are used. The cover is welded to the can. A glass-to-metal seal is used to insulate the positive terminal.

The *PulsesPlus*TM battery

Some applications require high current pulses of up to several Amperes in addition to low background current. Bobbin-type lithium batteries have high capacity and energy density, but low current capability due to their low rate design. To overcome this, *PulsesPlus*TM was developed, a hybrid battery that combines a bobbin-type cell with a patented high rate, low impedance HLC (hybrid layer capacitor). This hybrid system delivers extremely high currents with an excellent safety margin.

The Hybrid Layer Capacitor is charged by the battery. It has low output impedance and thus can readily deliver the pulses. It is recharged by the battery in advance of the next pulse, thus eliminating passivation effects.

High pulse applications involve low-background currents, and brief periods of high-current pulses over an extended period of time. These applications include automotive emergency roadside assistance systems, traffic telematics, GPS tracking devices, GSM modems, oceanographic devices, RFID transponders, automatic meter reading, security devices, emergency equipment, wireless sensors, defibrillators and other medical devices.

Please request additional information on the *PulsesPlus*TM battery and the HLC, or refer to our website.

Figure 1
Cross sectional view of a 1/2AA size cell (bobbin-design)

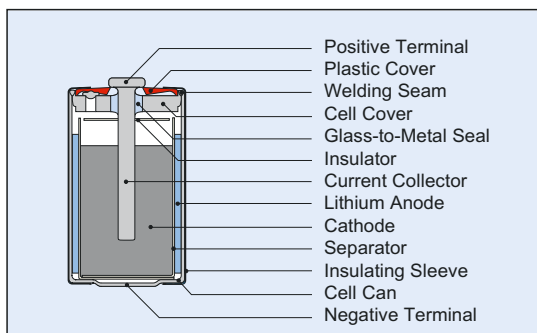

Sonnenschein Lithium
Product Data Catalogue

The chemical reaction

The battery consists of a lithium (Li) anode, a carbon (C) cathode, and a non-aqueous electrolyte (a solution of lithium tetrachloroaluminate in thionyl chloride). This solution performs a dual task: as the electrolyte for ion transport, and as an active depolarizer. The Teflon™-bonded carbon cathode serves as a catalyst for cathodic reduction.

The generally accepted reaction mechanisms are as follows:

Anodic reaction:



Cathodic reaction:

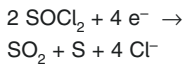

Overall reaction:

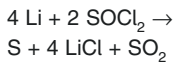

Most of the sulphur dioxide generated during discharge dissolves in the electrolyte, preventing pressure build-up within the battery.

Long-term behavior

The long shelf life of the Sonnenschein Lithium batteries is a result of the fact that a thin protective layer of LiCl forms on the anode as soon as the lithium first comes into contact with the electrolyte. This layer prevents further reaction or loss of capacity on stand. The problem of anode corrosion, as occurs in aqueous systems, is thus eliminated.

On the other hand, the protective layer on the anode may cause a delay in the voltage build-up if relatively high loads are applied, or after extended storage at elevated temperatures. This voltage delay is not experienced at all in microampere applications, such as in typical CMOS circuits.

Standards

General safety recommendations for lithium batteries have been published in the standards UL 1642 and IEC 60086-4.

UL-Recognition

Sonnenschein Lithium Batteries are recognized by UL under file MH 12827. The following text or a modified version thereof appears on each battery:

WARNING:
Fire, explosion, and severe burn hazard. Do not recharge, disassemble, heat above 100 °C, incinerate, or expose contents to water.

Protection against charging

Whenever lithium batteries are not the single power source in a circuit the following measures are recommended by the Underwriters Laboratories:

The battery should not be connected in series with an electrical power source that would increase the forward current through the battery.

The circuit shall include one of the following:

A. Two suitable diodes in series with the battery to prevent any reverse (charging) current. The second diode provides protection if the other one fails.

B. A blocking diode or the equivalent to prevent any reverse (charging) current and a resistor to limit current in case of a diode failure. The resistor should be sized to limit the reverse (charging) current to the maximums $I_{R, \max}$ shown below.

In addition to this UL requirement, which gives the safety limits, Sonnenschein Lithium recommend to limit the reverse (charging) current to values below 10 μA . This will ensure that service life is not affected.

Type	$I_{R, \max}$	Type	$I_{F, \max}$
SL-340	15 mA	SL-340	3 mA
SL-350	15 mA	SL-350	20 mA
SL-360	50 mA	SL-360	40 mA
SL-361	20 mA	SL-361	25 mA
SL-386	25 mA	SL-386	10 mA
SL-389	20 mA	SL-389	10 mA
SL-550	15 mA	SL-550	20 mA
SL-560	50 mA	SL-560	40 mA
SL-561	15 mA	SL-561	25 mA
SL-740	15 mA	SL-740	3 mA
SL-750	15 mA	SL-750	20 mA
SL-760	50 mA	SL-760	40 mA
SL-761	20 mA	SL-761	25 mA
SL-770	100 mA	SL-770	50 mA
SL-780	150 mA	SL-780	100 mA
SL-786	25 mA	SL-786	10 mA
SL-789	20 mA	SL-789	10 mA
SL-790	100 mA	SL-790	125 mA

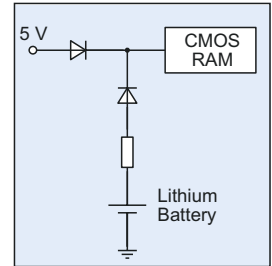

Figure 3
Safety wiring for memory back-up representing case B of UL recommendations.

Protection against forced discharge

Forced discharge of a cell can occur when it is connected in series with other cells and when it is not protected with a by-pass diode.

In these cases the maximum continuous discharge currents have to be reduced to the following values:

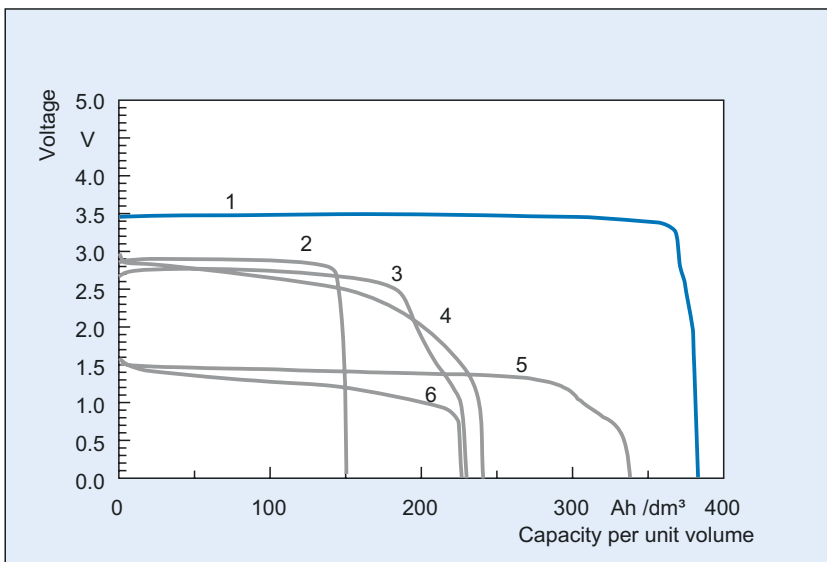

Figure 2
Comparison of different battery systems. The curves represent typical best values of commercial cylindrical cells when discharged at 25 °C at the 1000 hour rate. The area under the curves corresponds to the energy density listed below. The list also gives a note of the sealing method

1	Li/SOCl ₂	1280 Wh/dm ³	hermetically welded
2	Li/SO ₂	430 Wh/dm ³	hermetically welded
3	Li/CF _x	550 Wh/dm ³	crimped elastomer seal
4	Li/MnO ₂	580 Wh/dm ³	crimped elastomer seal or hermetically welded
5	Li/FeS ₂	450 Wh/dm ³	crimped elastomer seal
6	Alkaline	280 Wh/dm ³	crimped elastomer seal

Sonnenschein Lithium
Product Data Catalogue

Features and attributes of the various series

SL-300 series

Keywords: standard use and stand-by

- Excellent shelf life (10 years)
- Extremely low self-discharge (1 % or less per year)
- Suited for long-term use with low current
- For operation at low current levels with long stands
- Intermittent discharge with medium current level provided the average is not below the active current level
- Temperature range from -55°C to $+85^{\circ}\text{C}$ (flat cells up to $+75^{\circ}\text{C}$)
- Bobbin-type or flat cells

SL-500 series

Keyword: extended temperature range

- Extension of temperature range up to $+130^{\circ}\text{C}$
- Somewhat smaller capacity
- Otherwise like the SL-300 series

SL-700 series

Keyword: enhanced start

- Major improvement of voltage delay at the start of discharge at medium current levels (TMV)
- Intermittent discharge at medium current levels
- Best results if used after no more than 3 years of storage
- Otherwise like the SL-300 series

Computer batteries

- Supplied with plastic outer case, cable and connector
- Classified by UL as "user-replaceable"
- Some versions with current and/or voltage limitation
- Some versions contain two or more cells
- Otherwise like the SL-300 series

Customer Benefits

Sonnenschein Lithium has focused its ongoing efforts on promoting the understanding and further development of lithium batteries. This determination offers to the customer a number of decisive benefits such as:

- Access to over twenty-five years of experience in research and development, production and marketing
- Adaptability and reliability in meeting rapidly evolving customer needs
- Detailed technical support in terms of design and application — before, during and after the purchase
- Highly qualified experts available for support on short notice
- Customized production of single and multi-cell batteries to meet specific requirements
- Reliable delivery, secured by contractual agreements and second sourcing.

For successful use of a battery, the co-operation between the customer and the supplier must commence at the earliest possible point: at times it is simply more economical to design a circuit for the characteristics of the best suitable energy supply, rather than having to forgo its advantages because it is too late for changes.

Active current level

Discharge current of approx. $2\ \mu\text{A}/\text{cm}^2$ of anode surface. If a battery is operated at a constant current level that is higher than the active current, then its pulse current capability remains intact over its entire life.

Anode surface area

The anode surface area provides an indication of the current capability and design of a battery.

Available capacity

The diagrams showing available capacity give an indication of the confidence range of expected capacities at different current levels depending on ambient temperature.

Current drain ranges

This term stands for the actual load of the battery. The load is correlated with the duration of discharge to be expected on continuous current and an operating voltage above 3 Volts.

Low current drain:

Duration of discharge greater than 2000 hours

Medium current drain:

Duration of discharge between 20 and 2000 hours

High current drain:

Duration of discharge less than 20 hours

End voltage

The discharge curves shown in this catalogue assume that discharge continues until the voltage drops to 2 Volts. In most applications, this does not yield any major differences from the capacity achievable with higher end voltages (e.g. 3 Volts), since it is not usual for discharge to occur continuously at high or medium current levels.

Internal resistance

Internal resistance is defined as voltage drop divided by current. The value changes during the discharge. From the start, it drops to a steady state

value. Before the end voltage is reached, internal resistance rises due to the chemical and physical processes in the cell.

Internal resistance also depends on temperature, storage, and current levels involved.

Maximum continuous discharge current

Current yielding approximately 30% to 60% of the nominal capacity.

Nominal capacity

The average capacity of a battery type under favorable conditions (load, ambient temperature). In the diagrams showing "Available Capacity", the nominal capacity is marked with a dot.

Nominal current

Current level at which the nominal capacity can be obtained.

Nominal voltage

The nominal voltage characterizes the electrochemical system (in this case, Li/SOCl_2). It results during discharge at low current drain levels.

Operating voltage

The average voltage during discharge at a given load and temperature.

Orientation effect

A reduction of available capacity observed on cells of size C and larger when discharged upside down at low and ambient temperature.

Pulse current capability

Current level yielding approximately 30% to 60% nominal capacity when a 1s pulse is applied once a minute.

TMV, transient minimum voltage

The minimum voltage experienced during the voltage delay when a battery is first connected to a load.

General Notes

The data given in this catalogue is purely descriptive. It depends also on the given application and is not to be regarded as the warranty of a quality or as an extension of the defects liability periods valid in accordance with our respective business conditions.

Data subject to change.

Keyword:
Standard Use and
Stand-By



Type: SL-340

Performance Data **Size BEL**
(Typical values for batteries stored at 25°C for one year)

System	Li/SOCl ₂
Nominal voltage	3.6 V
Nominal capacity	0.40 Ah
Nominal current	0.3 mA
Max. continuous discharge current	3 mA
Anode surface area	2.4 cm ²
Weight	5 g
Volume	1.2 cm ³
Temperature range	-55...+75 °C

WARNING:
Fire, explosion, and severe burn hazard. Do not recharge, disassemble, heat above 100 °C, incinerate, or expose contents to water.

See page 4 for further safety recommendations.

Typical Discharge Curves at +25°C

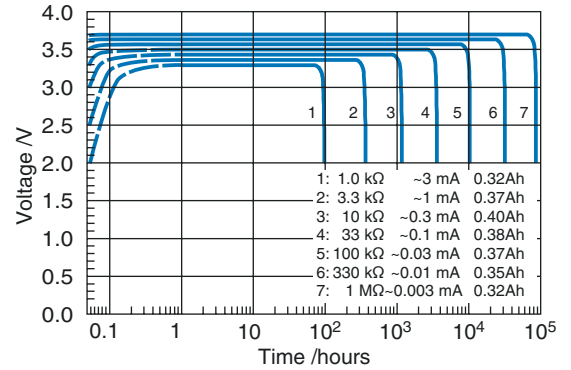

SL-340

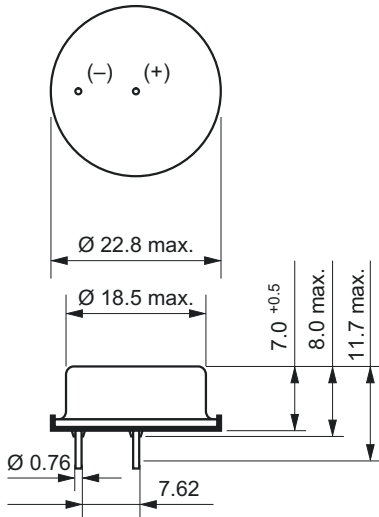

Available Capacity

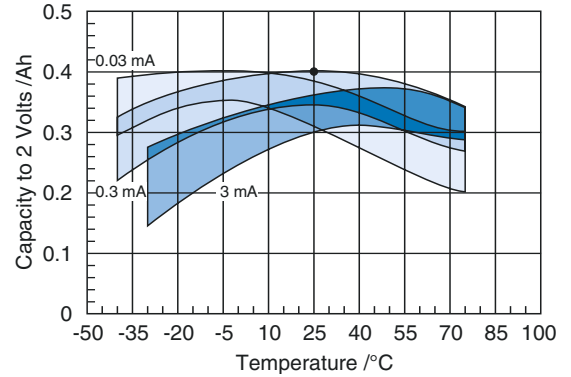

Operating Voltage

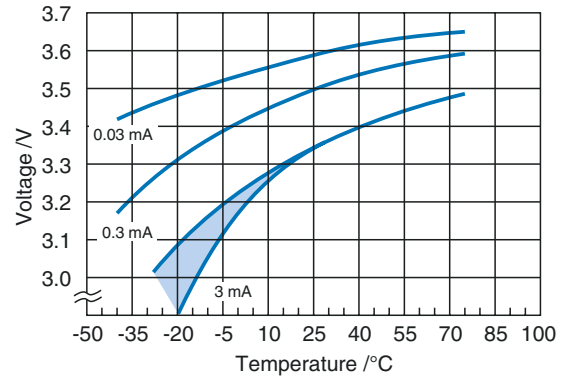

Available Terminations

SL-340 Pins

Catalogue No.

11 1 13404 00

Any values given here are for information purposes only. They also depend on actual conditions of use and are not warranties of future performance. Subject to change.



Keyword:
Standard Use and Stand-By

Type: SL-389

Performance Data Size 1/10D
(Typical values for batteries stored at 25°C for one year)

System	Li/SOCl ₂
Nominal voltage	3.6 V
Nominal capacity	1.0 Ah
Nominal current	1 mA
Max. continuous discharge current	10 mA
Anode surface area	7.5 cm ²
Weight	17 g
Volume	5 cm ³
Temperature range	-55...+75 °C

WARNING:
Fire, explosion, and severe burn hazard. Do not recharge, disassemble, heat above 100 °C, incinerate, or expose contents to water.

See page 4 for further safety recommendations.

Typical Discharge Curves at +25°C

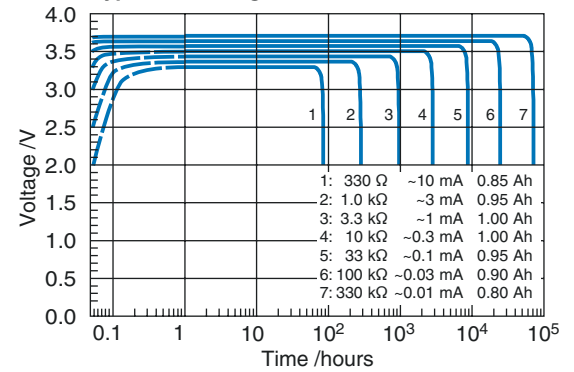

SL-389

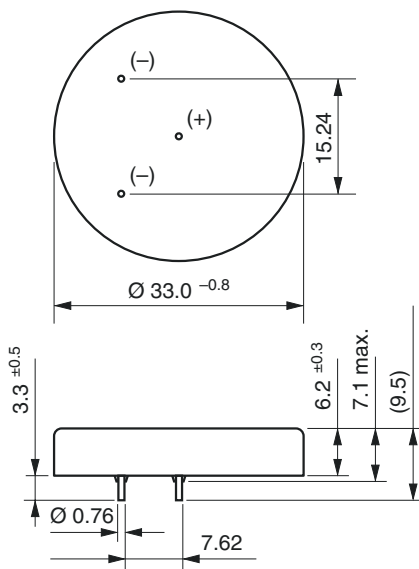

Available Capacity

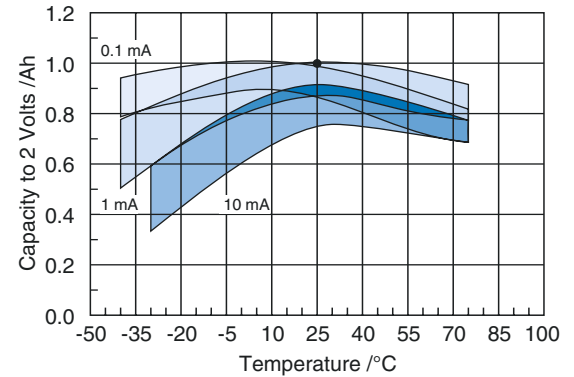

Operating Voltage

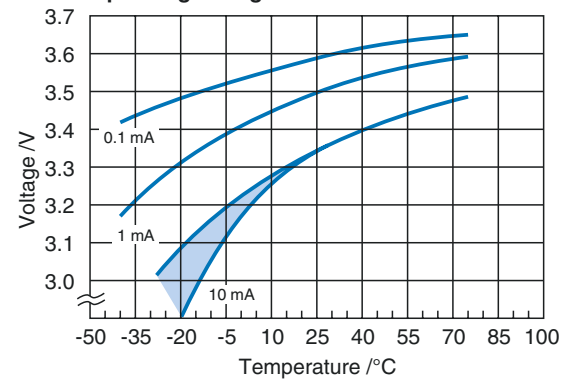

Available Terminations

SL-389 Pins

Catalogue No.

11 1 13894 00

Any values given here are for information purposes only. They also depend on actual conditions of use and are not warranties of future performance. Subject to change.

Keyword:
Standard Use and
Stand-By



Type: SL-386

Performance Data **Size 1/8D**
(Typical values for batteries stored at 25°C for one year)

System	Li/SOCl ₂
Nominal voltage	3.6 V
Nominal capacity	1.7 Ah
Nominal current	1 mA
Max. continuous discharge current	10 mA
Anode surface area	7.5 cm ²
Weight	22 g
Volume	8.2 cm ³
Temperature range	-55...+75°C

WARNING:
Fire, explosion, and severe burn hazard. Do not recharge, disassemble, heat above 100°C, incinerate, or expose contents to water.

See page 4 for further safety recommendations.

Typical Discharge Curves at +25°C

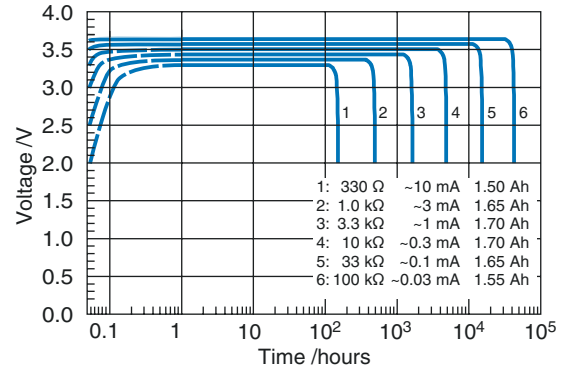

SL-386

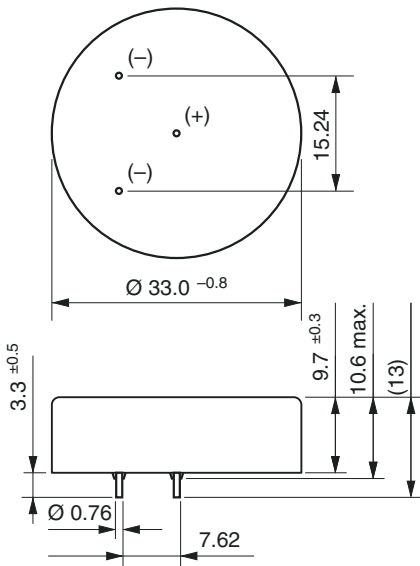

Available Capacity

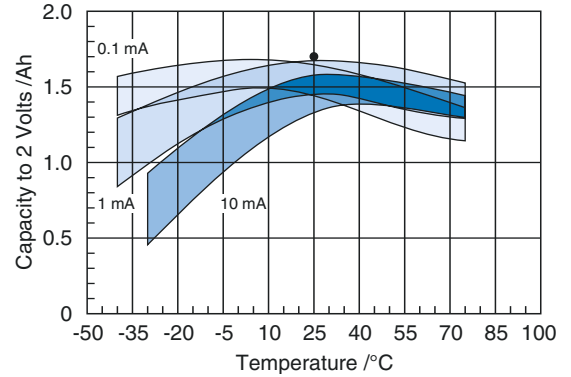

Operating Voltage

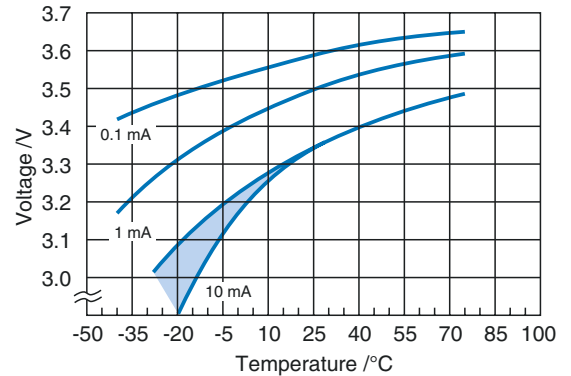

Available Terminations **Catalogue No.**

SL-386 Pins

11 1 03864 00

Any values given here are for information purposes only. They also depend on actual conditions of use and are not warranties of future performance. Subject to change.



Keyword:
Standard Use and Stand-By

Type: SL-350

Performance Data Size ½AA
(Typical values for batteries stored at 25°C for one year)

System	Li/SOCl ₂
Nominal capacity	1.0 Ah
Nominal voltage	3.6 V
Nominal current	0.6 mA
Max. continuous discharge current	6 mA
Anode surface area	6 cm ²
Weight	9 g
Volume	4.3 cm ³
Temperature range	-55...+85 °C

WARNING:
Fire, explosion, and severe burn hazard. Do not recharge, disassemble, heat above 100 °C, incinerate, or expose contents to water.

See page 4 for further safety recommendations.

Typical Discharge Curves at +25°C

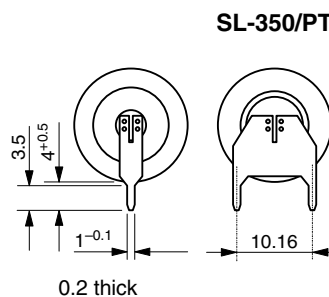
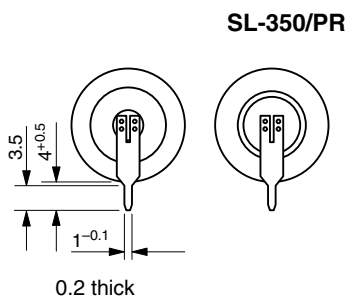
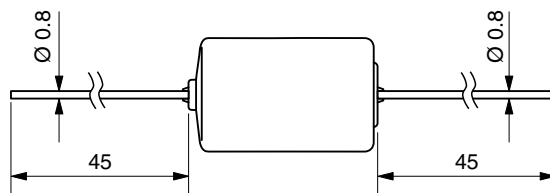
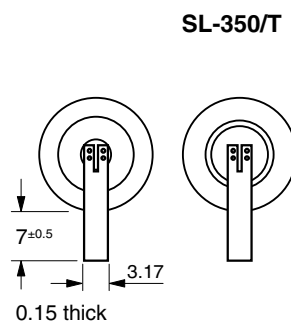
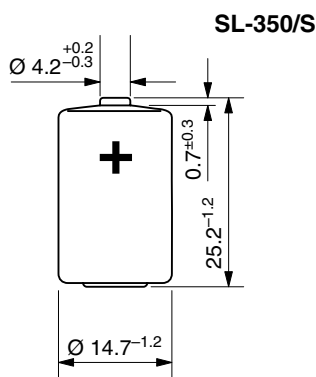
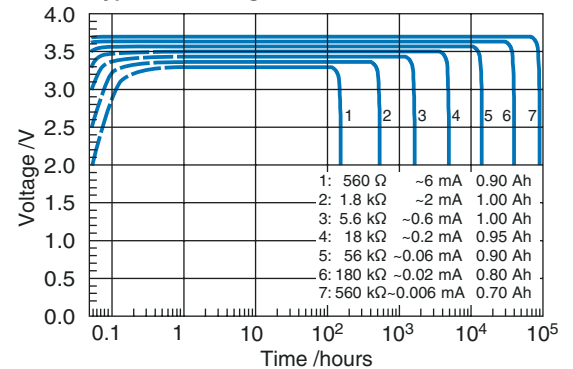

Available Capacity

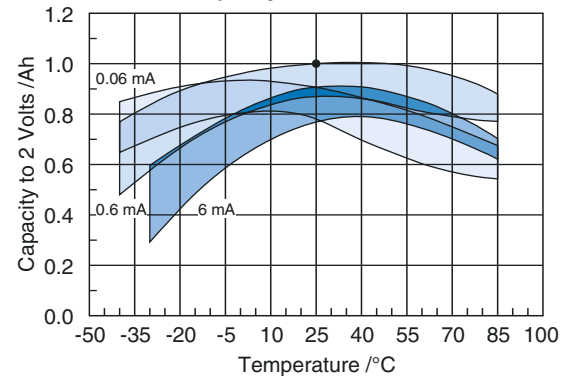

Operating Voltage

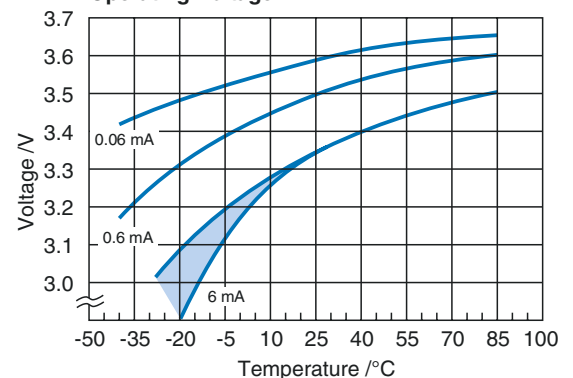

Available Terminations

SL-350/S	Standard
SL-350/T	Tags
SL-350/P	Pins
SL-350/PR	Pins Radial
SL-350/PT	Polarized Tags

Catalogue No.

11 1 03501 00
11 1 03502 00
11 1 03503 00
11 1 03506 00
11 1 03508 00

Any values given here are for information purposes only. They also depend on actual conditions of use and are not warranties of future performance. Subject to change.

Keyword:
Standard Use and
Stand-By



Type: SL-361

Performance Data **Size** 2/3AA
(Typical values for batteries stored at 25°C for one year)

System	Li/SOCl ₂
Nominal voltage	3.6 V
Nominal capacity	1.45 Ah
Nominal current	1 mA
Max. continuous discharge current	10 mA
Anode surface area	9 cm ²
Weight	12 g
Volume	5.7 cm ³
Temperature range	-55...+85 °C

WARNING:
Fire, explosion, and severe burn hazard. Do not recharge, disassemble, heat above 100 °C, incinerate, or expose contents to water.

See page 4 for further safety recommendations.

Typical Discharge Curves at +25°C

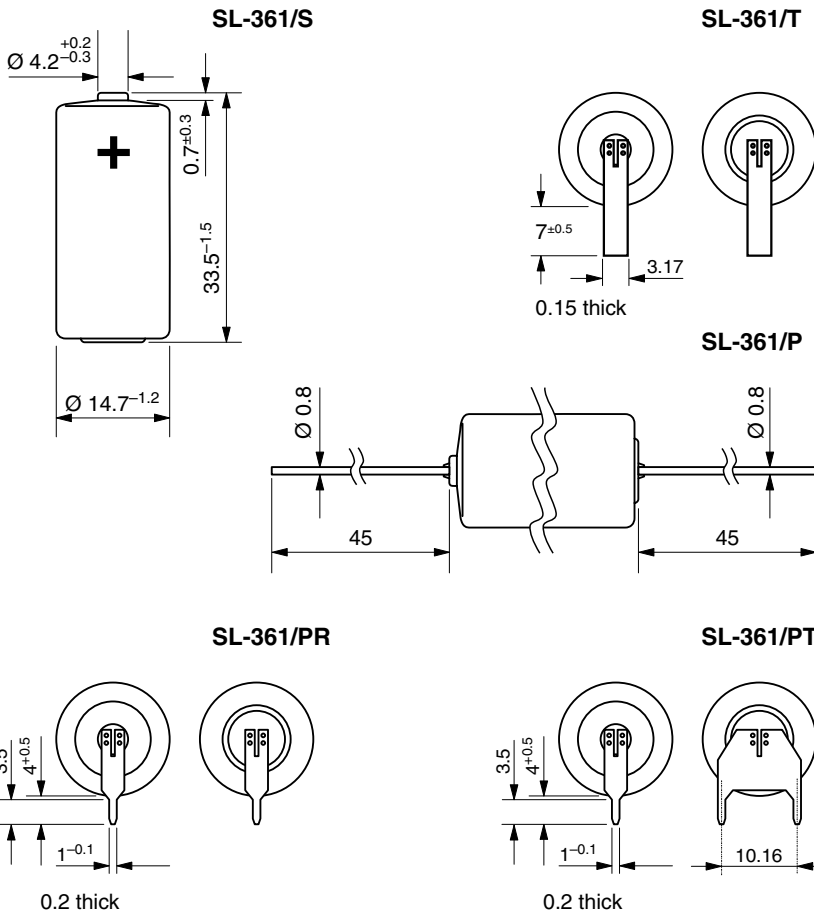
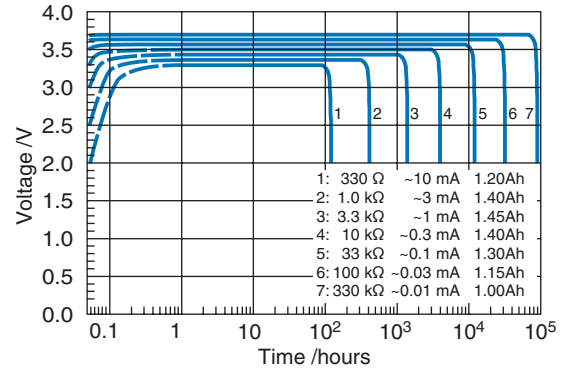

Available Capacity

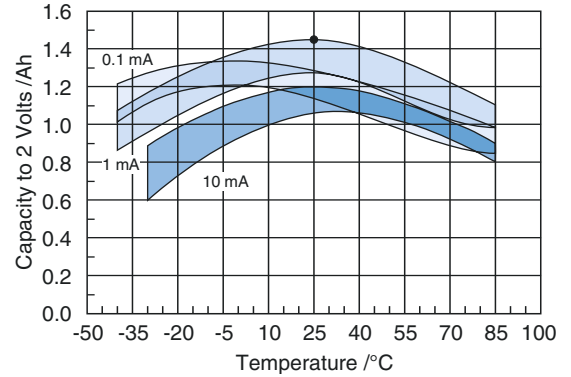

Operating Voltage

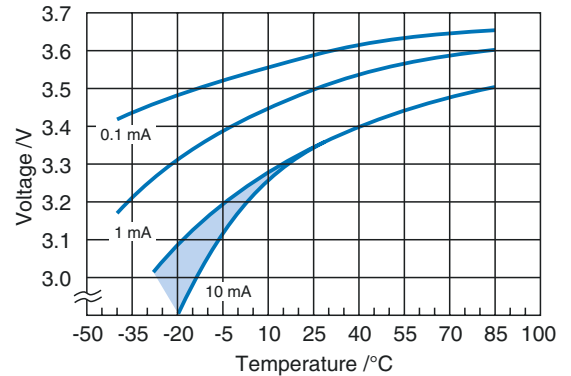

Available Terminations

SL-361/S	Standard
SL-361/T	Tags
SL-361/P	Pins
SL-361/PR	Pins Radial
SL-361/PT	Polarized Tags

Catalogue No.

11 1 03611 00
11 1 03612 00
11 1 03613 00
11 1 03616 00
11 1 03618 00

Any values given here are for information purposes only. They also depend on actual conditions of use and are not warranties of future performance. Subject to change.



Keyword:
Standard Use and Stand-By

Type: SL-360

Performance Data **Size AA**
(Typical values for batteries stored at 25°C for one year)

System	Li/SOCl ₂
Nominal voltage	3.6 V
Nominal capacity	2.3 Ah
Nominal current	2 mA
Max. continuous discharge current	20 mA
Anode surface area	14 cm ²
Weight	18 g
Volume	8.0 cm ³
Temperature range	-55...+85 °C

WARNING:
Fire, explosion, and severe burn hazard. Do not recharge, disassemble, heat above 100 °C, incinerate, or expose contents to water.

See page 4 for further safety recommendations.

Typical Discharge Curves at +25°C

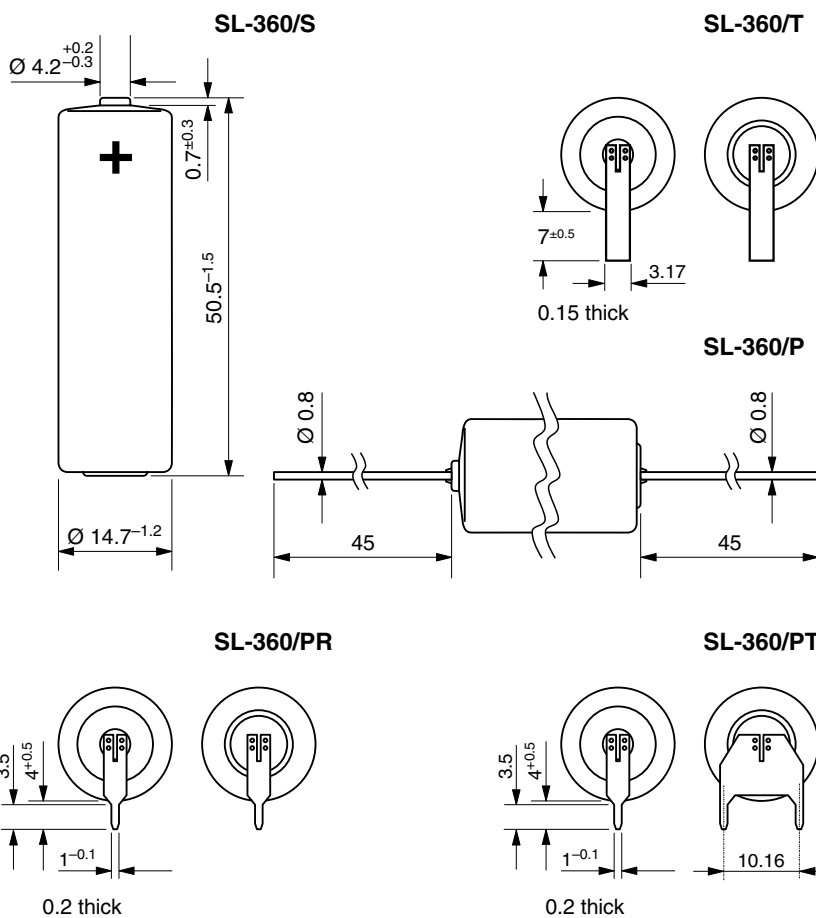
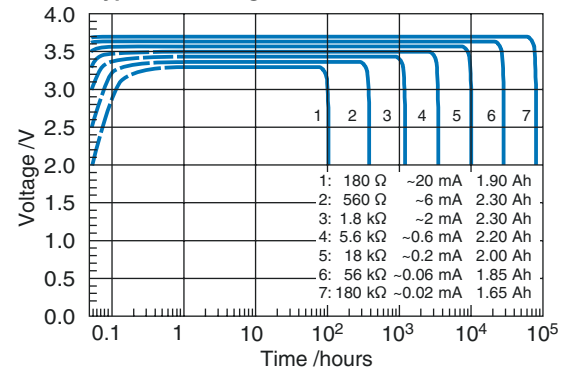

Available Capacity

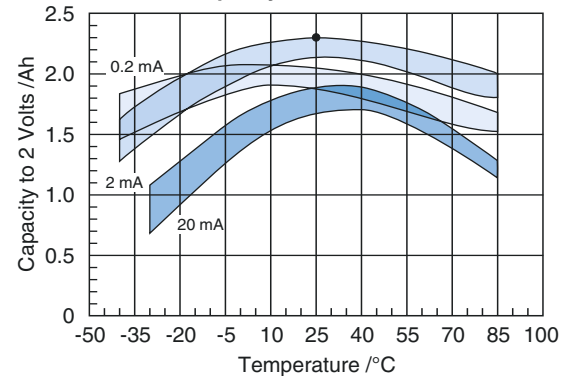

Operating Voltage

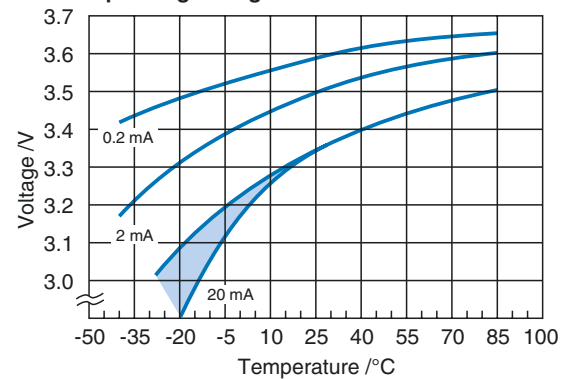

Available Terminations

SL-360/S	Standard
SL-360/T	Tags
SL-360/P	Pins
SL-360/PR	Pins Radial
SL-360/PT	Polarized Tags

Catalogue No.

11 1 03601 00
11 1 03602 00
11 1 03603 00
11 1 03606 00
11 1 03608 00

Keyword:
Extended Temperature Range



Type: SL-550

Performance Data (Typical values for batteries stored at 25°C for one year)

System	Li/SOCl ₂
Nominal voltage	3.6 V
Nominal capacity	0.8 Ah
Nominal current	0.6 mA
Max. continuous discharge current	6 mA
Anode surface area	6 cm ²
Weight	9 g
Volume	4.3 cm ³
Temperature range	-55...+130 °C

WARNING:
Fire, explosion, and severe burn hazard. Do not recharge, disassemble, heat above 145 °C, incinerate, or expose contents to water.

See page 4 for further safety recommendations.

Typical Discharge Curves at +85°C

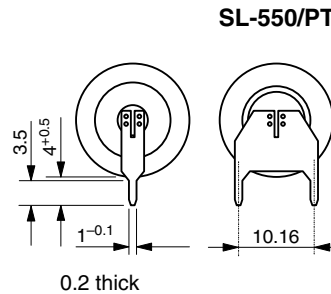
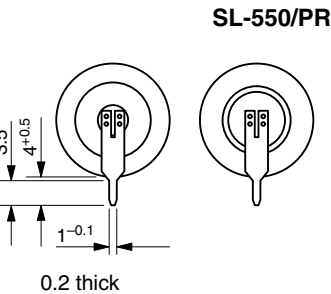
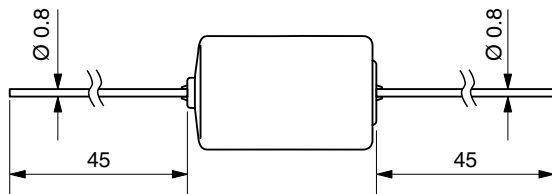
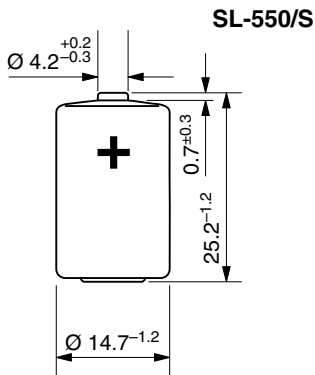
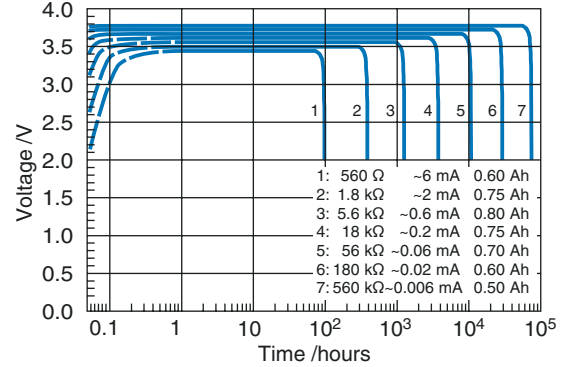

Available Capacity

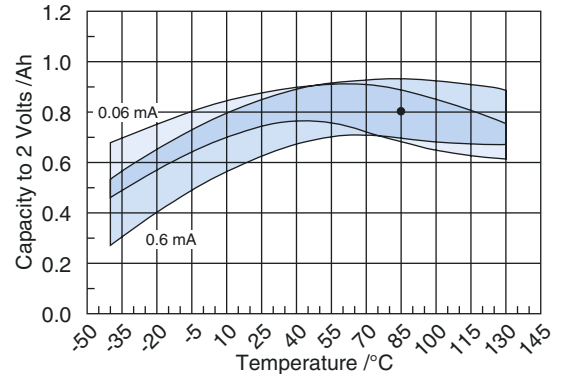

Operating Voltage

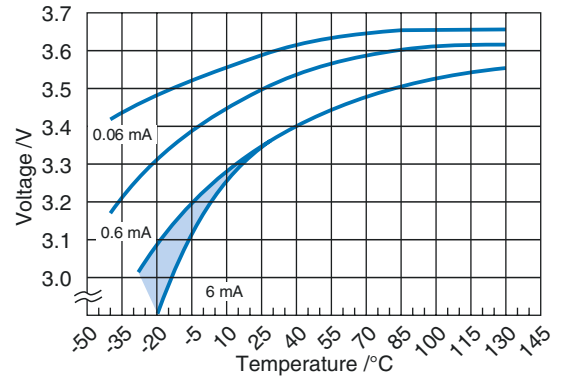

Available Terminations

SL-550/S	Standard
SL-550/T	Tags
SL-550/P	Pins
SL-550/PR	Pins Radial
SL-550/PT	Polarized Tags

Catalogue No.

11 1 05501 00
11 1 05502 00
11 1 05503 00
11 1 05506 00
11 1 05508 00

Any values given here are for information purposes only. They also depend on actual conditions of use and are not warranties of future performance. Subject to change.



Keyword:
Extended Temperature Range

Type: SL-561

Performance Data (Typical values for batteries stored at 25°C for one year) **Size** ⅓AA

System	Li/SOCl ₂
Nominal voltage	3.6 V
Nominal capacity	1.0 Ah
Nominal current	1 mA
Max. continuous discharge current	10 mA
Anode surface area	9 cm ²
Weight	12 g
Volume	5.7 cm ³
Temperature range	-55...+130°C

WARNING:
Fire, explosion, and severe burn hazard. Do not recharge, disassemble, heat above 145°C, incinerate, or expose contents to water.

See page 4 for further safety recommendations.

Typical Discharge Curves at +85°C

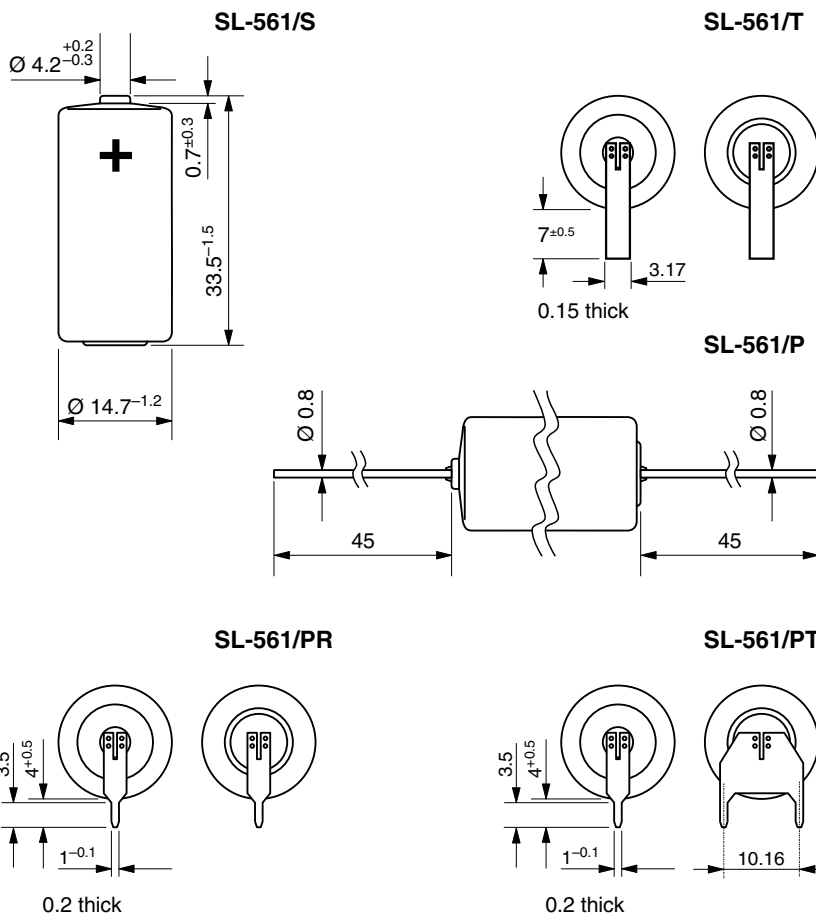
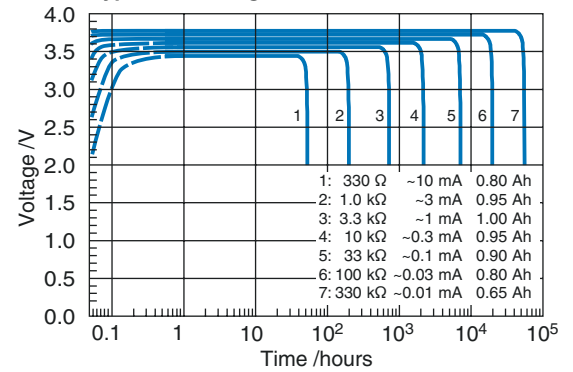

Available Capacity

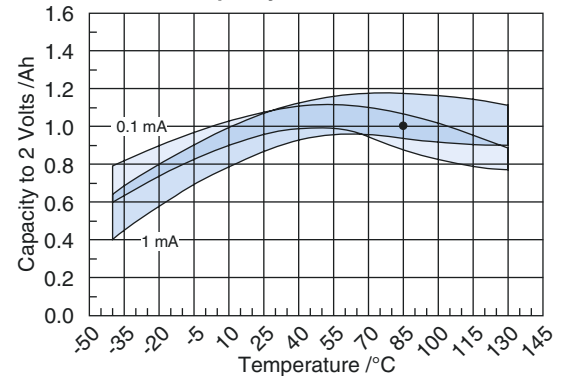

Operating Voltage

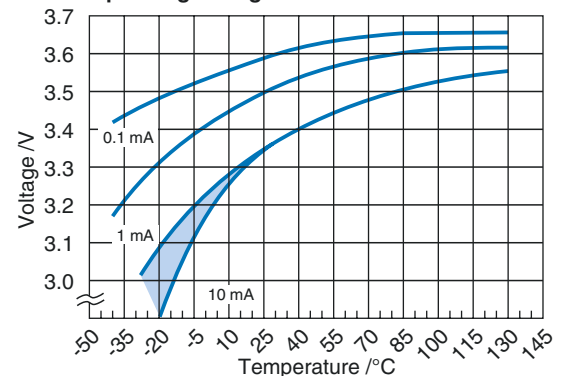

Available Terminations

SL-561/S	Standard
SL-561/T	Tags
SL-561/P	Pins
SL-561/PR	Pins Radial
SL-561/PT	Polarized Tags

Catalogue No.

11 1 05611 00
11 1 05612 00
11 1 05613 00
11 1 05616 00
11 1 05618 00

Any values given here are for information purposes only. They also depend on actual conditions of use and are not warranties of future performance. Subject to change.

Keyword:
Extended Temperature Range



Type: SL-560

Performance Data
(Typical values for batteries stored at 25°C for one year)

System	Li/SOCl ₂
Nominal voltage	3.6 V
Nominal capacity	1.7 Ah
Nominal current	2 mA
Max. continuous discharge current	20 mA
Anode surface area	14 cm ²
Weight	18 g
Volume	8.0 cm ³
Temperature range	-55...+130 °C

WARNING:
Fire, explosion, and severe burn hazard. Do not recharge, disassemble, heat above 145 °C, incinerate, or expose contents to water.

See page 4 for further safety recommendations.

Typical Discharge Curves at +85°C

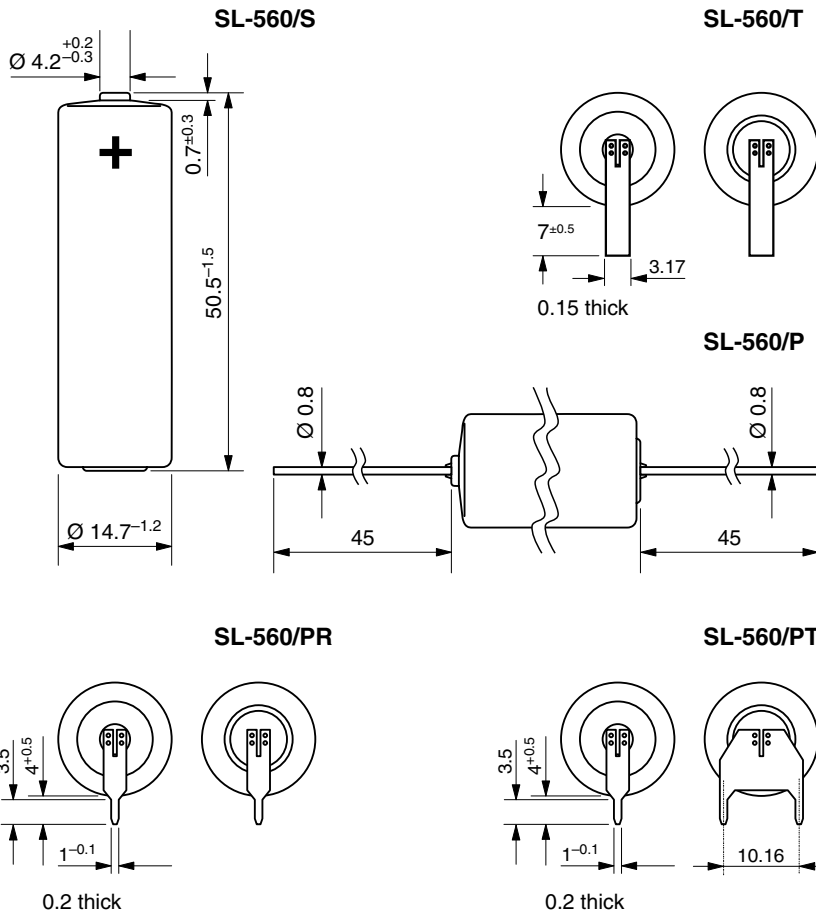
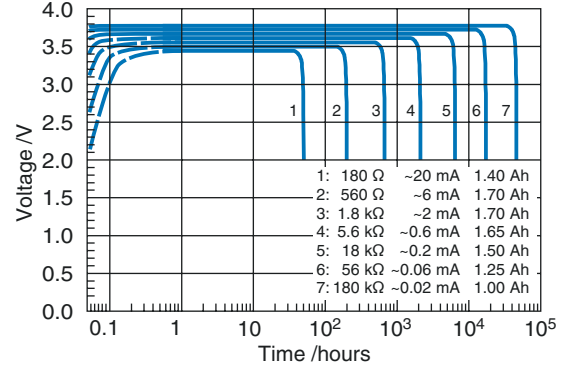

Available Capacity

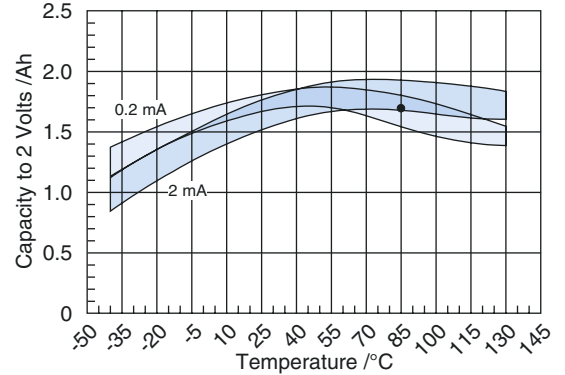

Operating Voltage

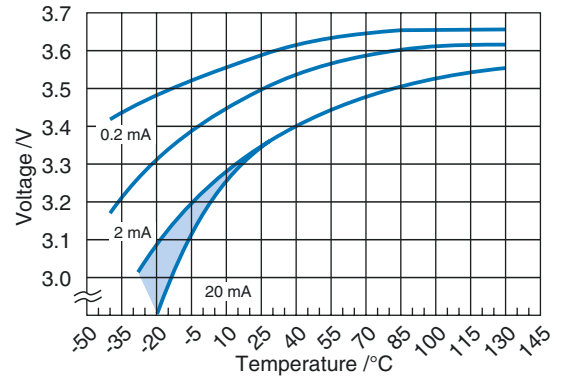

Available Terminations

SL-560/S	Standard
SL-560/T	Tags
SL-560/P	Pins
SL-560/PR	Pins Radial
SL-560/PT	Polarized Tags

Catalogue No.

11 1 05601 00
11 1 05602 00
11 1 05603 00
11 1 05606 00
11 1 05608 00

Any values given here are for information purposes only. They also depend on actual conditions of use and are not warranties of future performance. Subject to change.



Keyword:
Enhanced Start

Type: SL-740

Performance Data (Typical values for batteries stored at 25°C for one year) **Size BEL**

System	Li/SOCl ₂
Nominal voltage	3.6 V
Nominal capacity	0.37 Ah
Nominal current	0.3 mA
Max. continuous discharge current	3 mA
Pulse current capability	10 mA
Anode surface area	2.4 cm ²
Weight	5 g
Volume	1.2 cm ³
Temperature range	-55...+75 °C

WARNING:
Fire, explosion, and severe burn hazard. Do not recharge, disassemble, heat above 100 °C, incinerate, or expose contents to water.

See page 4 for further safety recommendations.

Typical Discharge Curves at +25°C

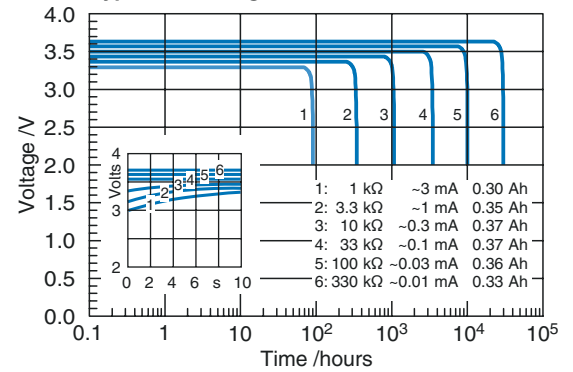

SL-740

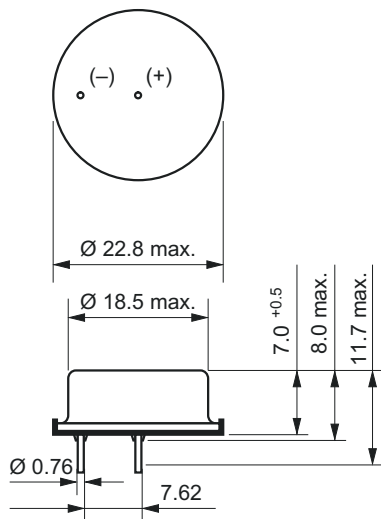

Available Capacity

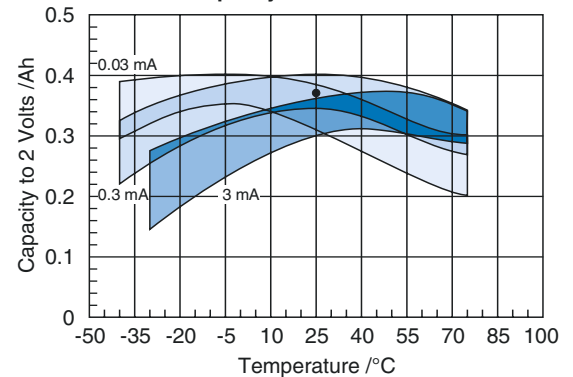

Operating Voltage

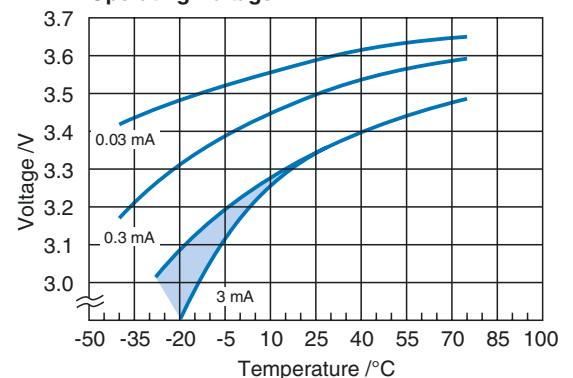

Available Terminations

SL-740 Pins

Catalogue No.

11 1 17404 00

Any values given here are for information purposes only. They also depend on actual conditions of use and are not warranties of future performance. Subject to change.

Keyword:
Enhanced Start



Type: SL-789

Performance Data **Size** 1/40D
(Typical values for batteries stored at 25°C for one year)

System	Li/SOCl ₂
Nominal voltage	3.6 V
Nominal capacity	0.95 Ah
Nominal current	1 mA
Max. continuous discharge current	10 mA
Pulse current capability	20 mA
Anode surface area	7.5 cm ²
Weight	17 g
Volume	5 cm ³
Temperature range	-55...+75 °C

WARNING:
Fire, explosion, and severe burn hazard. Do not recharge, disassemble, heat above 100 °C, incinerate, or expose contents to water.

See page 4 for further safety recommendations.

Typical Discharge Curves at +25°C

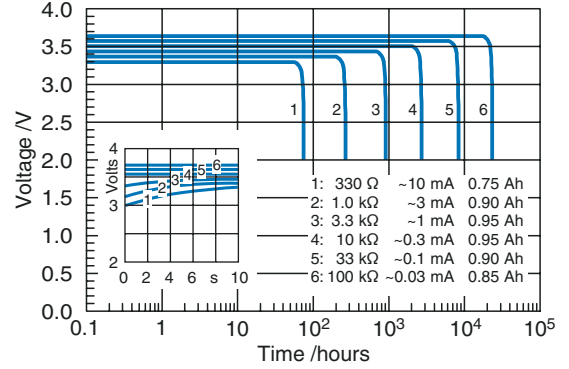

SL-789

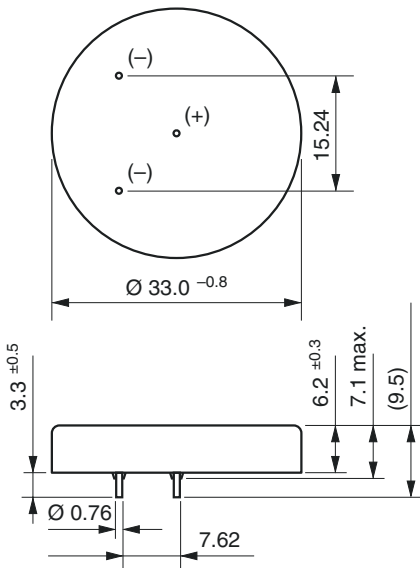

Available Capacity

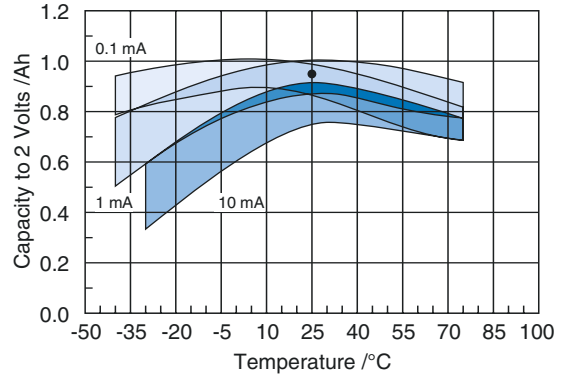

Operating Voltage

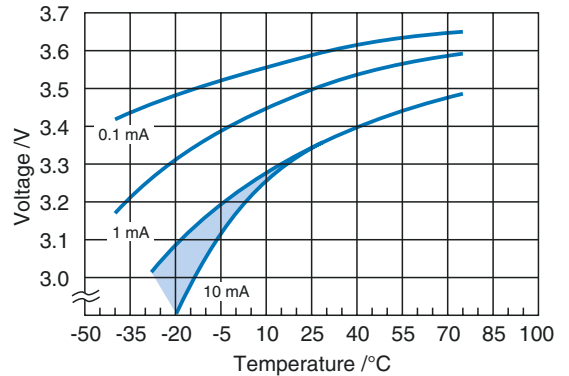

Available Terminations **Catalogue No.**

SL-789 Pins 11 1 17894 00

Any values given here are for information purposes only. They also depend on actual conditions of use and are not warranties of future performance. Subject to change.



Keyword:
Enhanced Start

Type: **SL-786**

Performance Data **Size 1/6D**
(Typical values for batteries stored at 25°C for one year)

System	Li/SOCl ₂
Nominal voltage	3.6 V
Nominal capacity	1.6 Ah
Nominal current	1 mA
Max. continuous discharge current	10 mA
Pulse current capability	20 mA
Anode surface area	7.5 cm ²
Weight	22 g
Volume	8.2 cm ³
Temperature range	-55...+75 °C

WARNING:
Fire, explosion, and severe burn hazard. Do not recharge, disassemble, heat above 100 °C, incinerate, or expose contents to water.

See page 4 for further safety recommendations.

Typical Discharge Curves at +25°C

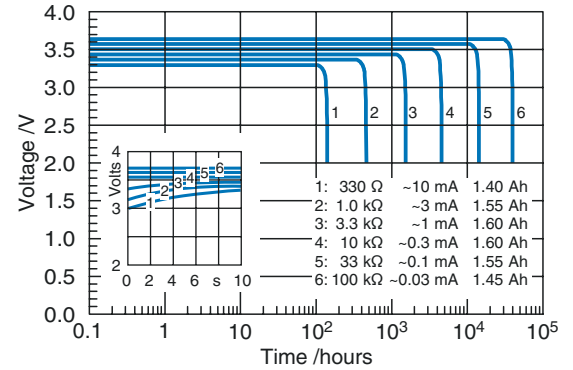

SL-786

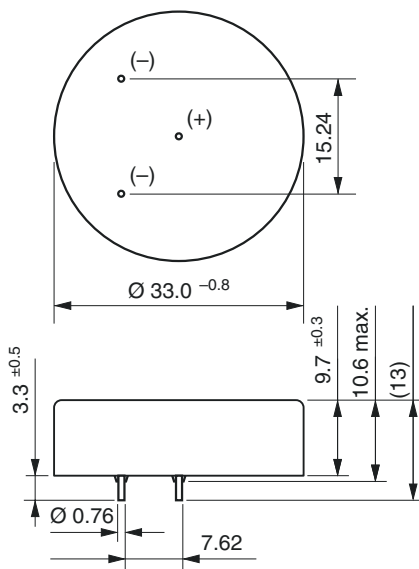

Available Capacity

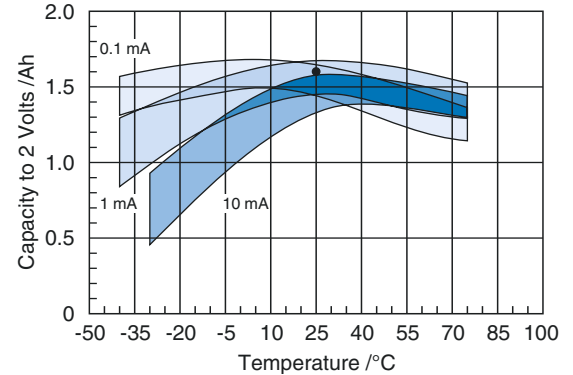

Operating Voltage

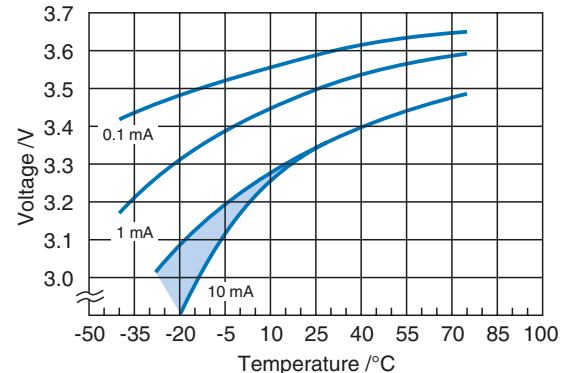

Available Terminations **Catalogue No.**

SL-786 Pins 11 1 17864 00

Any values given here are for information purposes only. They also depend on actual conditions of use and are not warranties of future performance. Subject to change.

Keyword:
Enhanced Start



Type: SL-750

Performance Data (Typical values for batteries stored at 25°C for one year)

System	Li/SOCl ₂
Nominal voltage	3.6 V
Nominal capacity	0.95 Ah
Nominal current	0.6 mA
Max. continuous discharge current	20 mA
Pulse current capability	60 mA
Anode surface area	6 cm ²
Weight	9 g
Volume	4.3 cm ³
Temperature range	-55...+85°C

WARNING:
Fire, explosion, and severe burn hazard. Do not recharge, disassemble, heat above 100°C, incinerate, or expose contents to water.

See page 4 for further safety recommendations.

Typical Discharge Curves at +25°C

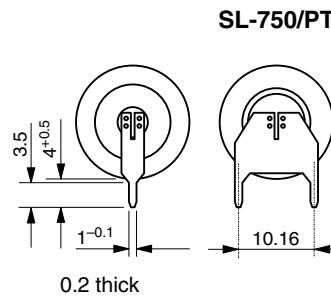
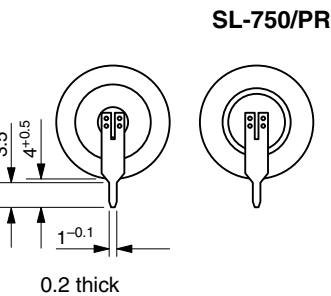
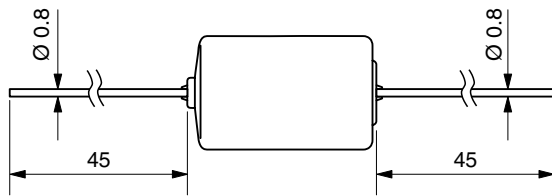
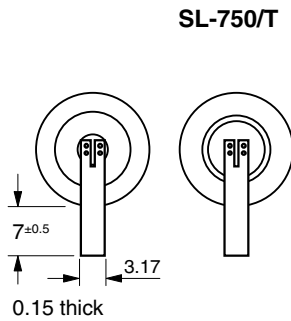
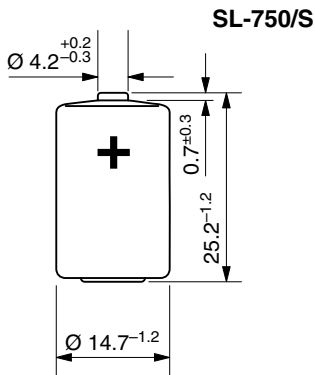
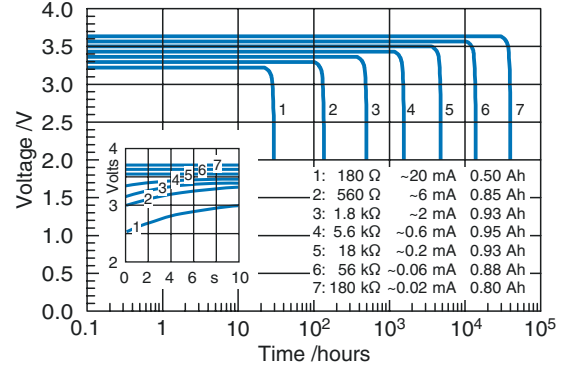

Available Capacity

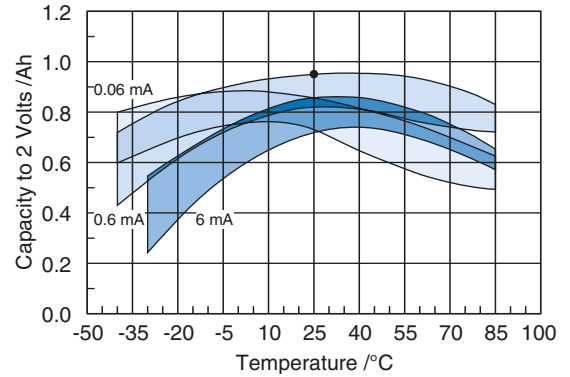

Operating Voltage

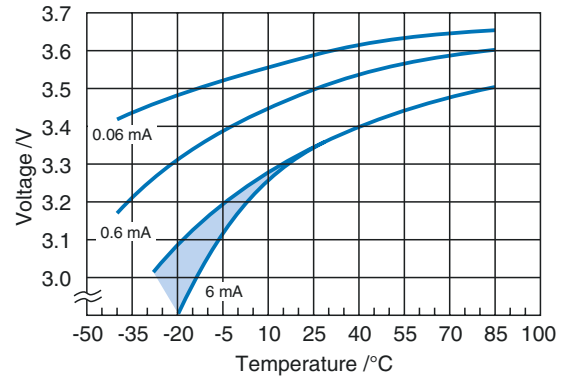

Pulse Discharge Characteristics at +25°C

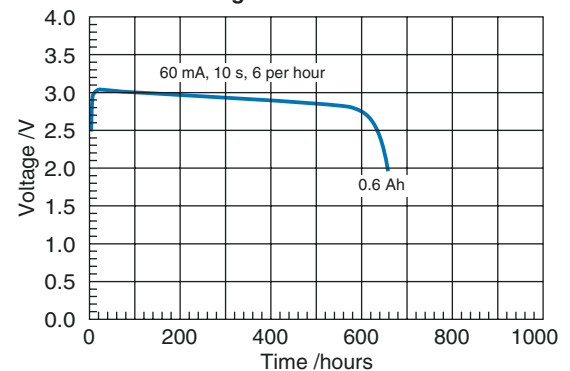

Available Terminations

SL-750/S	Standard
SL-750/T	Tags
SL-750/P	Pins
SL-750/PR	Pins Radial
SL-750/PT	Polarized Tags

Catalogue No.

11 1 07501 00
11 1 07502 00
11 1 07503 00
11 1 07506 00
11 1 07508 00

Any values given here are for information purposes only. They also depend on actual conditions of use and are not warranties of future performance. Subject to change.



Keyword:
Enhanced Start

Type: SL-761

Performance Data (Typical values for batteries stored at 25°C for one year) **Size** ⅓AA

System	Li/SOCl ₂
Nominal voltage	3.6 V
Nominal capacity	1.35 Ah
Nominal current	1 mA
Max. continuous discharge current	30 mA
Pulse current capability	90 mA
Anode surface area	9 cm ²
Weight	12 g
Volume	5.7 cm ³
Temperature range	-55...+85 °C

WARNING:
Fire, explosion, and severe burn hazard. Do not recharge, disassemble, heat above 100 °C, incinerate, or expose contents to water.

See page 4 for further safety recommendations.

Typical Discharge Curves at +25°C

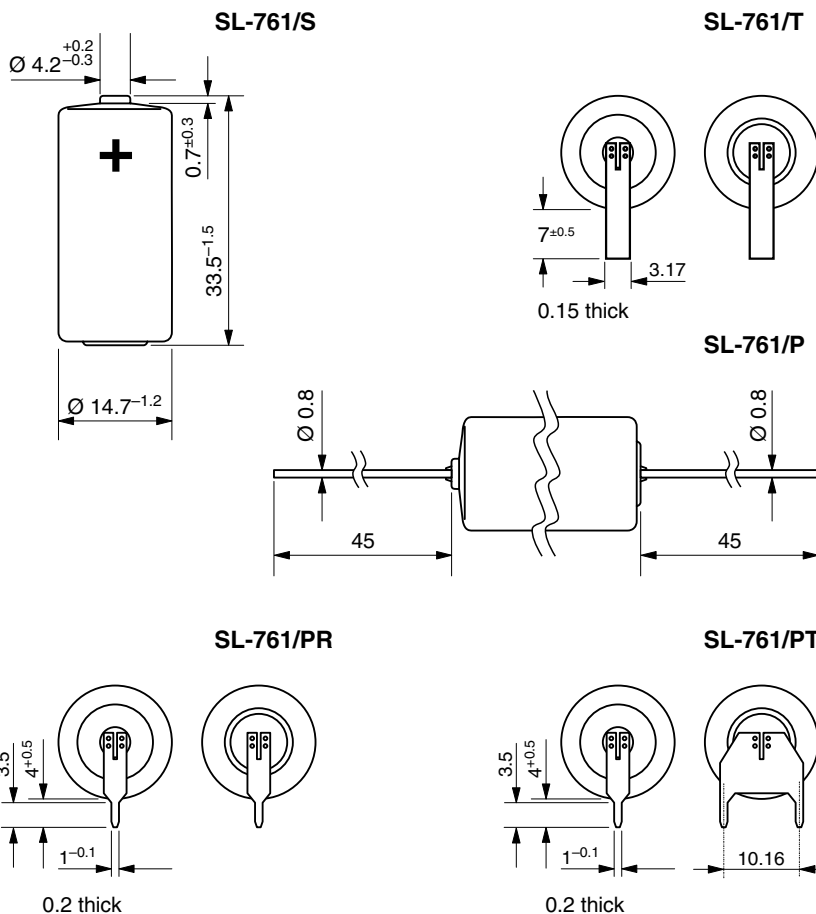
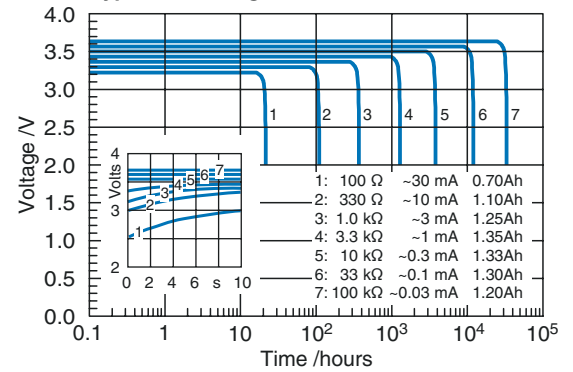

Available Capacity

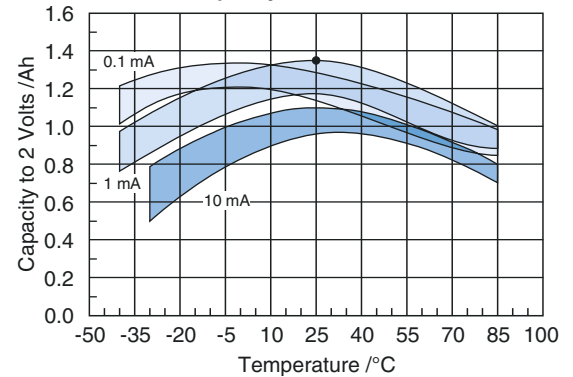

Operating Voltage

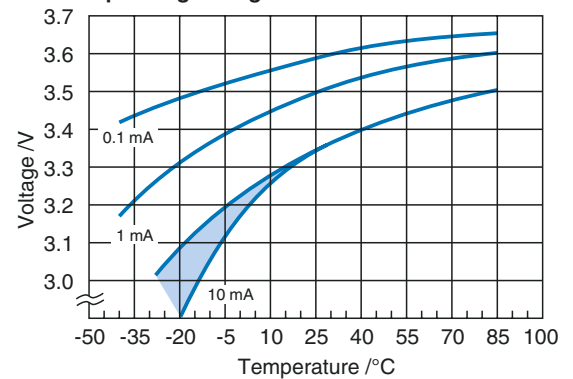

Pulse Discharge Characteristics at +25°C

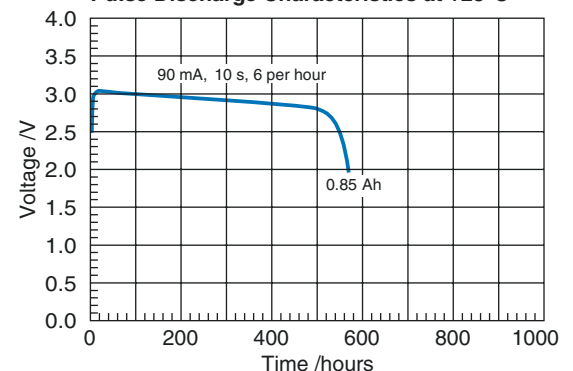

Available Terminations

SL-761/S	Standard
SL-761/T	Tags
SL-761/P	Pins
SL-761/PR	Pins Radial
SL-761/PT	Polarized Tags

Catalogue No.

11 1 07611 00
11 1 07612 00
11 1 07613 00
11 1 07616 00
11 1 07618 00

Any values given here are for information purposes only. They also depend on actual conditions of use and are not warranties of future performance. Subject to change.

Keyword:
Enhanced Start



Type: SL-760

Performance Data (Typical values for batteries stored at 25°C for one year)

System	Li/SOCl ₂
Nominal voltage	3.6 V
Nominal capacity	2.1 Ah
Nominal current	2 mA
Max. continuous discharge current	60 mA
Pulse current capability	140 mA
Anode surface area	14 cm ²
Weight	18 g
Volume	8.0 cm ³
Temperature range	-55...+85°C

WARNING:
Fire, explosion, and severe burn hazard. Do not recharge, disassemble, heat above 100°C, incinerate, or expose contents to water.

See page 4 for further safety recommendations.

Typical Discharge Curves at +25°C

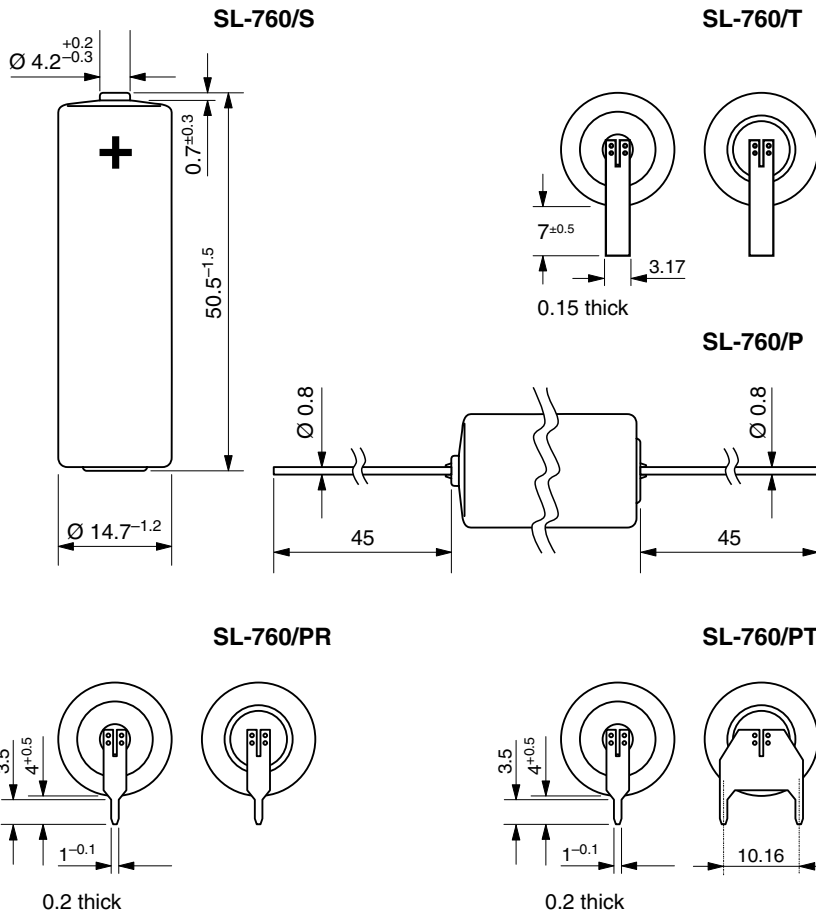
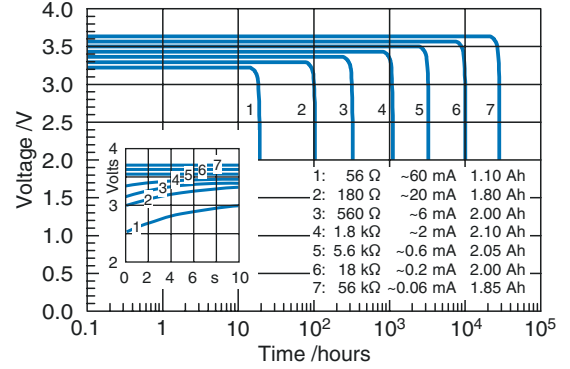

Available Capacity

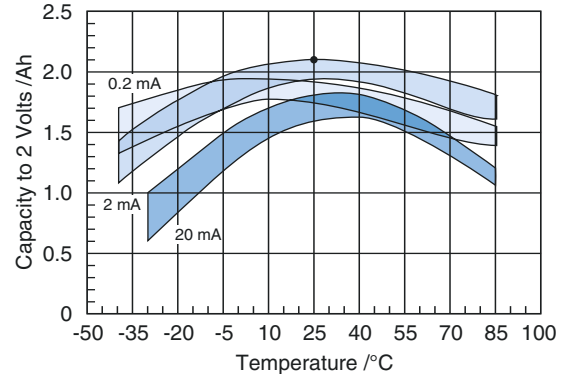

Operating Voltage

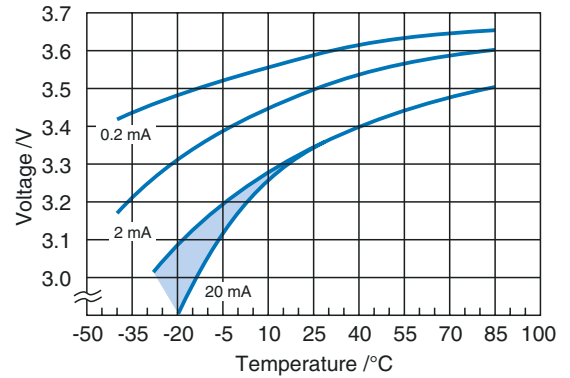

Pulse Discharge Characteristics at +25°C

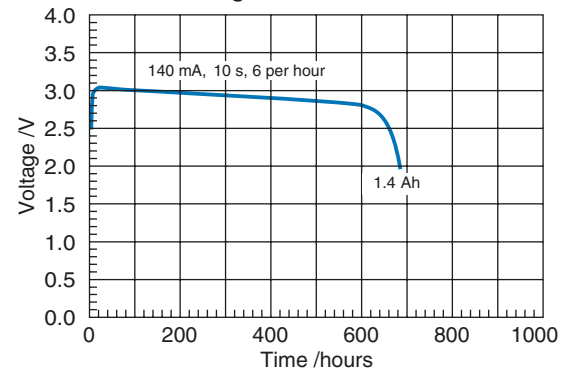

Available Terminations

SL-760/S	Standard
SL-760/T	Tags
SL-760/P	Pins
SL-760/PR	Pins Radial
SL-760/PT	Polarized Tags

Catalogue No.

11 1 07601 00
11 1 07602 00
11 1 07603 00
11 1 07606 00
11 1 07608 00

Any values given here are for information purposes only. They also depend on actual conditions of use and are not warranties of future performance. Subject to change.



Keyword:
Enhanced Start

Type: SL-770

Performance Data (Typical values for batteries stored at 25°C for one year)

	Size C
System	Li/SOCl ₂
Nominal voltage	3.6 V
Nominal capacity	7.2 Ah
Nominal current	3 mA
Max. continuous discharge current	100 mA
Pulse current capability	300 mA
Anode surface area	30 cm ²
Weight	50 g
Volume	26 cm ³
Temperature range	-55...+85 °C

WARNING:
Fire, explosion, and severe burn hazard. Do not recharge, disassemble, heat above 100 °C, incinerate, or expose contents to water.

See page 4 for further safety recommendations.

Typical Discharge Curves at +25°C

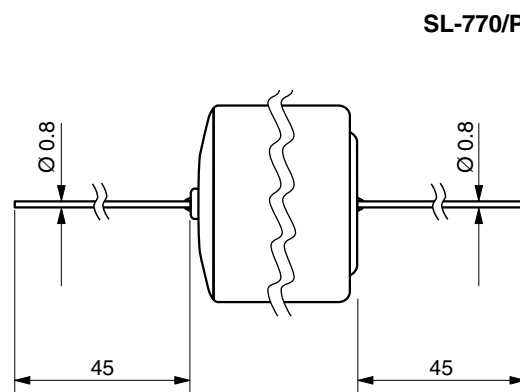
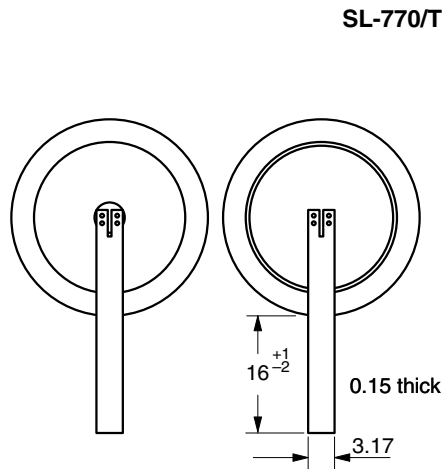
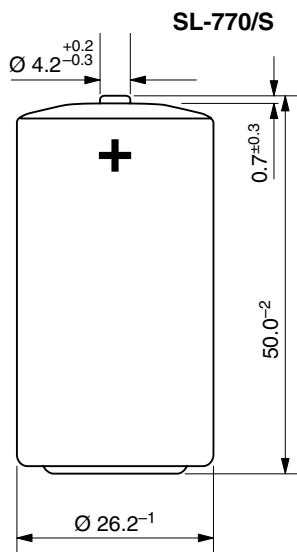
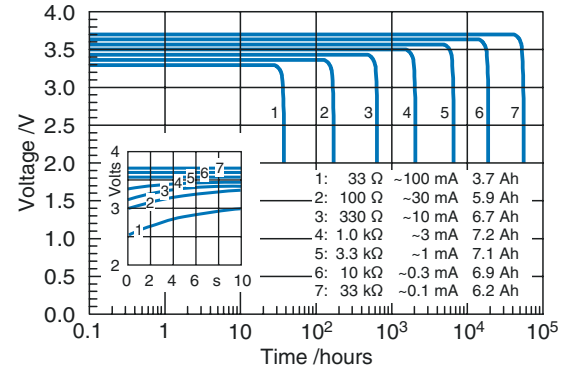

Available Capacity

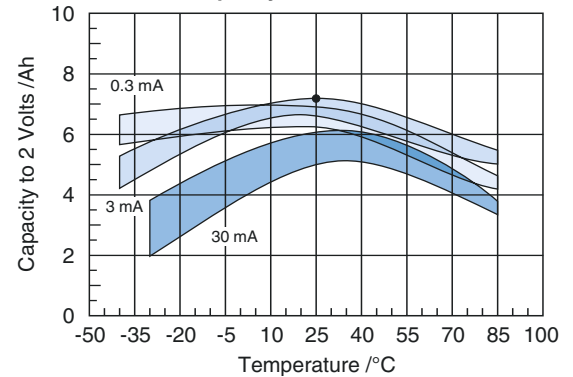

Operating Voltage

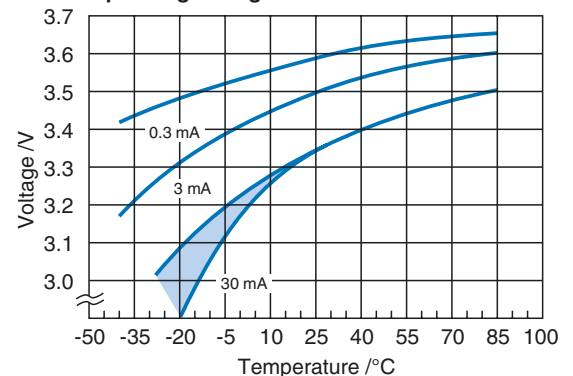

Pulse Discharge Characteristics at +25°C

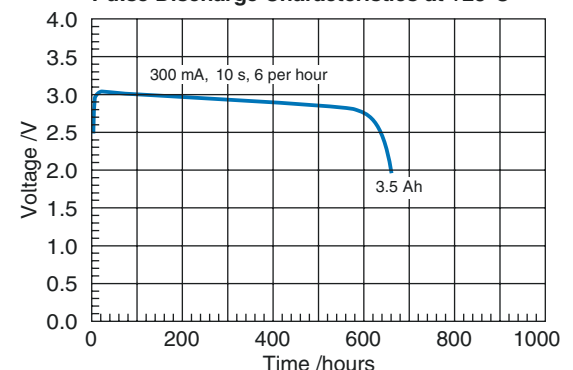

Available Terminations

SL-770/S	Standard
SL-770/T	Tags
SL-770/P	Pins

Catalogue No.

11 1 17701 00
11 1 17702 00
11 1 17703 00

Any values given here are for information purposes only. They also depend on actual conditions of use and are not warranties of future performance. Subject to change.

Keyword:
Enhanced Start

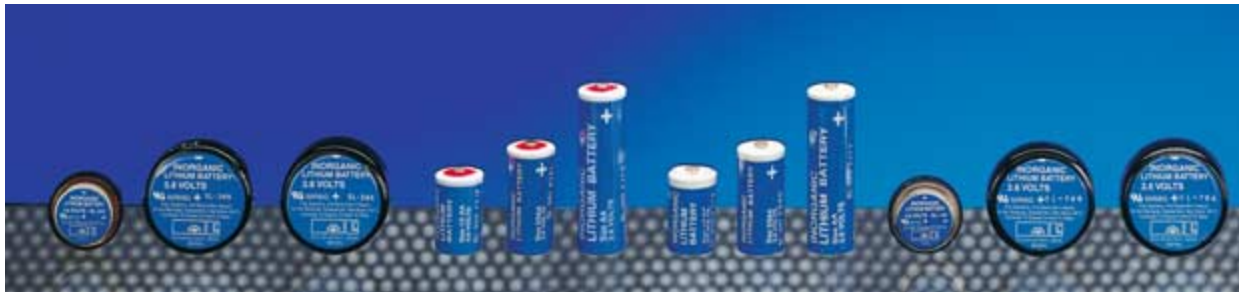

Type: SL-780

Performance Data (Typical values for batteries stored at 25°C for one year)

System	Li/SOCl ₂
Nominal voltage	3.6 V
Nominal capacity	16.5 Ah
Nominal current	6 mA
Max. continuous discharge current	200 mA
Pulse current capability	450 mA
Anode surface area	45 cm ²
Weight	92 g
Volume	51 cm ³
Temperature range	-55...+85 °C

WARNING:
Fire, explosion, and severe burn hazard. Do not recharge, disassemble, heat above 100 °C, incinerate, or expose contents to water.

See page 4 for further safety recommendations.

Typical Discharge Curves at +25°C

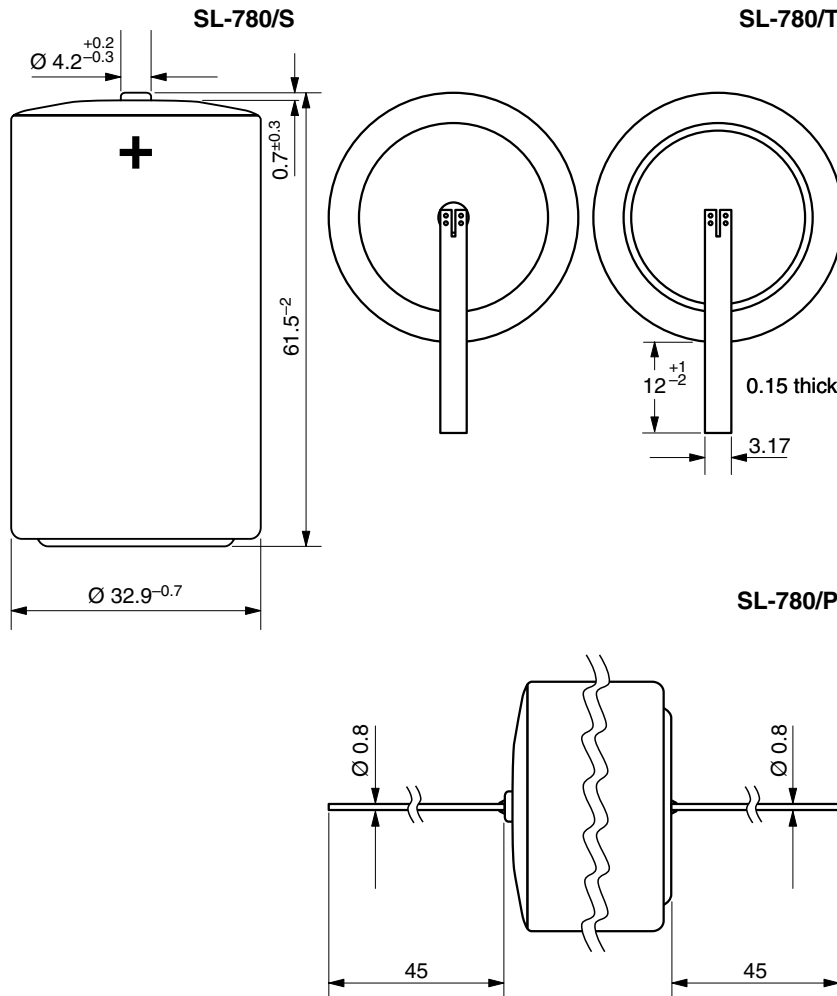
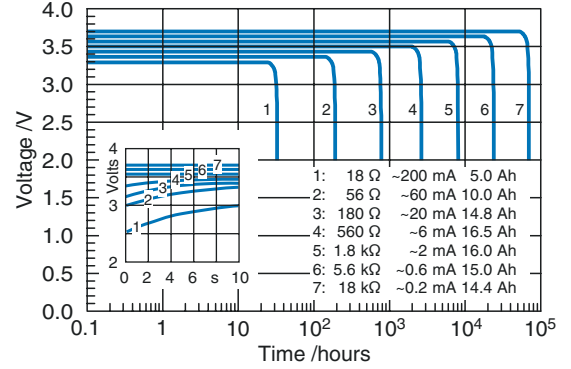

Available Capacity

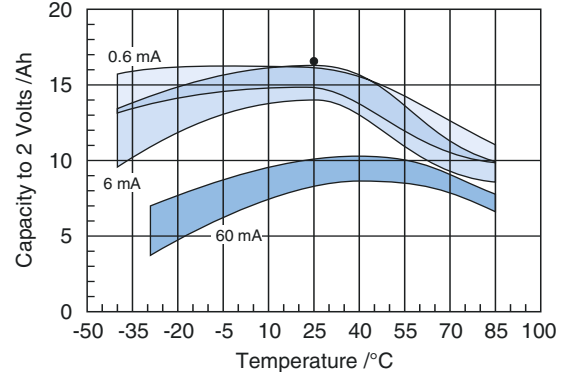

Operating Voltage

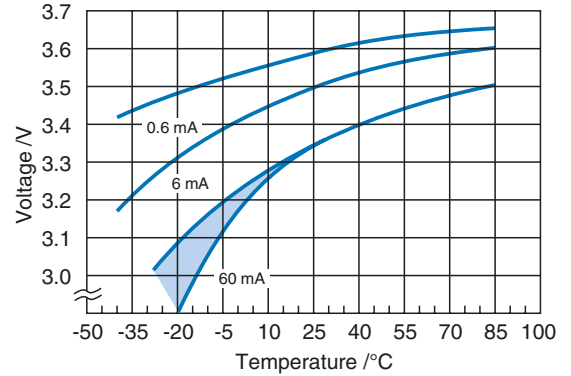

Pulse Discharge Characteristics at +25°C

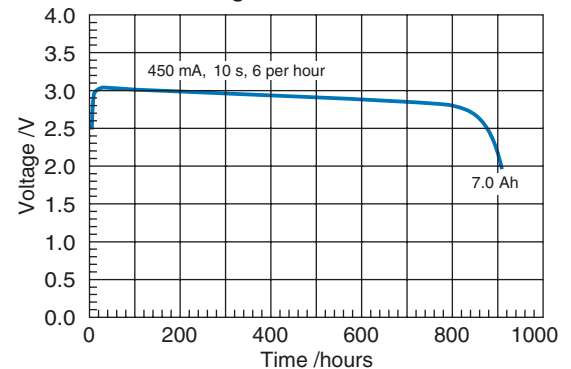

Available Terminations **Catalogue No.**

SL-780/S	Standard	11 1 17801 00
SL-780/T	Tags	11 1 17802 00
SL-780/P	Pins	11 1 17803 00

Any values given here are for information purposes only. They also depend on actual conditions of use and are not warranties of future performance. Subject to change.



Keyword:
Enhanced Start

Type: SL-790

Performance Data (Typical values for batteries stored at 25°C for one year)

	Size DD
System	Li/SOCl ₂
Nominal voltage	3.6 V
Nominal capacity	35 Ah
Nominal current	10 mA
Max. continuous discharge current	300 mA
Pulse current capability	900 mA
Anode surface area	90 cm ²
Weight	195 g
Volume	100 cm ³
Temperature range	-55...+85 °C

WARNING:
Fire, explosion, and severe burn hazard. Do not recharge, disassemble, heat above 100 °C, incinerate, or expose contents to water.

See page 4 for further safety recommendations.

Typical Discharge Curves at +25°C

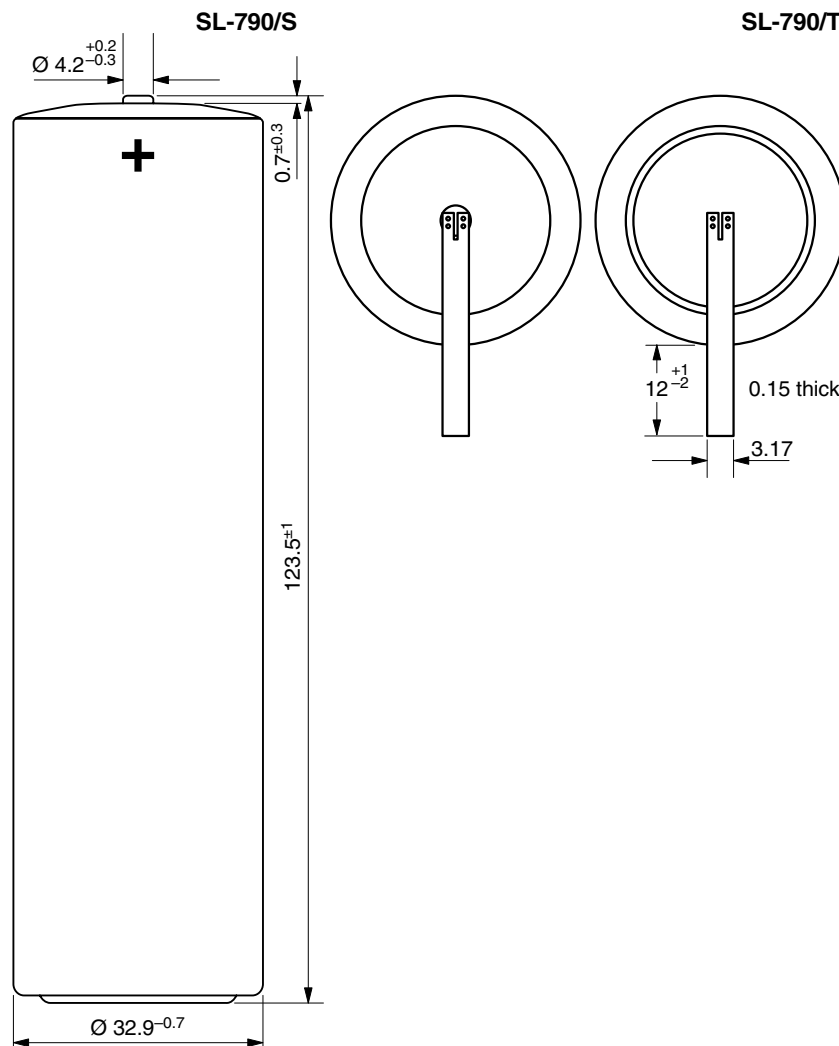
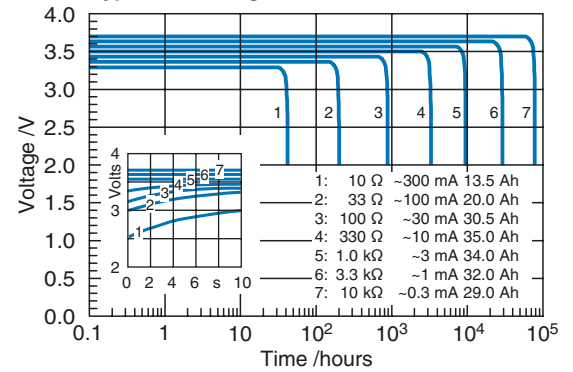

Available Terminations

SL-790/S	Standard
SL-790/T	Tags

Catalogue No.

11 1 17901 00
11 1 17902 00

Any values given here are for information purposes only. They also depend on actual conditions of use and are not warranties of future performance. Subject to change.

Available Capacity

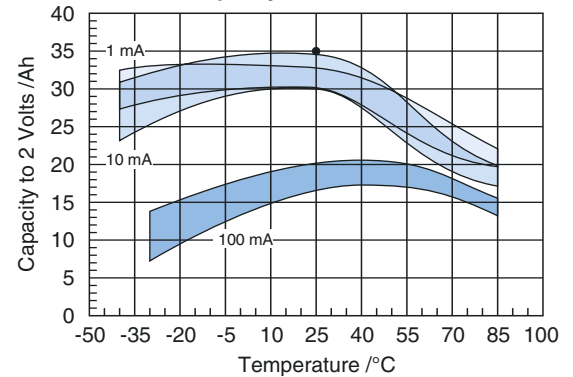

Operating Voltage

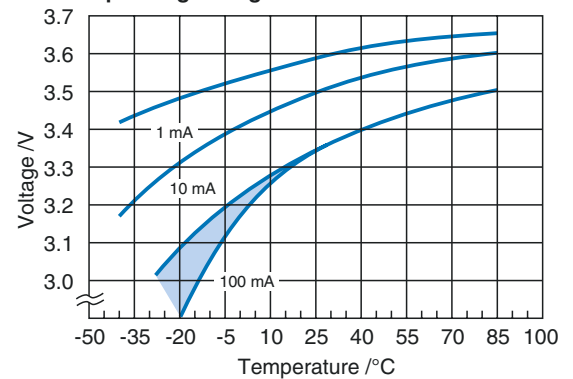

Pulse Discharge Characteristics at +25°C

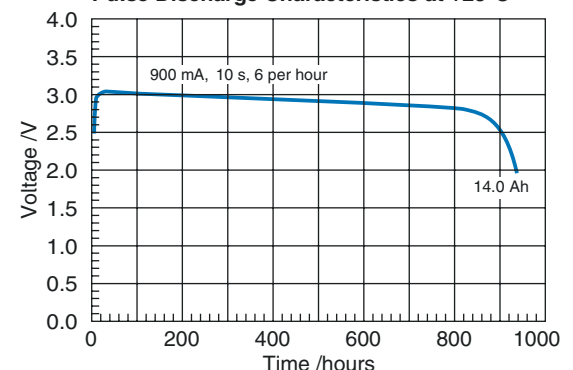

Keyword:
Computer Battery

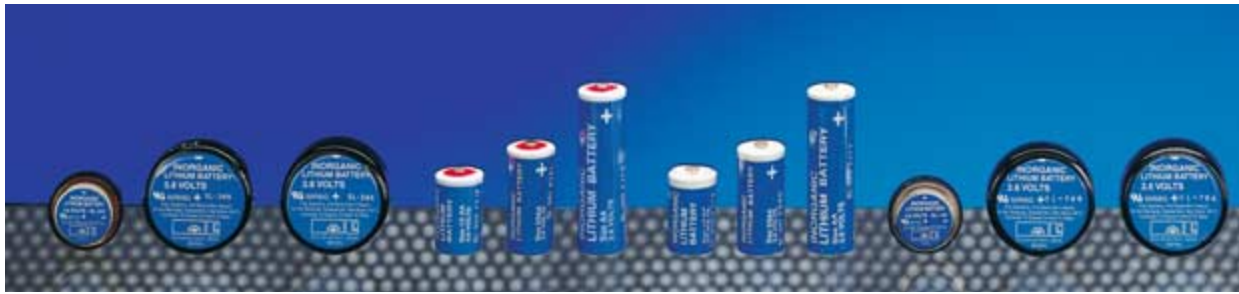

Type: SL-360/461

Performance Data
(Typical values for batteries stored at 25°C for one year)

System	Li/SOCl ₂
Nominal voltage	3.6 V
Nominal capacity	2.1 Ah
Nominal current	2 mA
Max. continuous discharge current	20 mA
Wires	AWG 24
Housing	UL 94V2
Classification	user replaceable
Weight	26 g
Temperature range	-55...+85 °C

WARNING:
Fire, explosion, and severe burn hazard. Do not recharge, disassemble, heat above 100 °C, incinerate, or expose contents to water.

See page 4 for further safety recommendations.

Typical Discharge Curves at +25°C

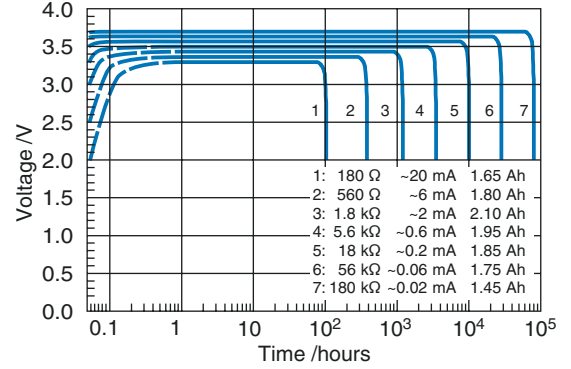

SL-360/461

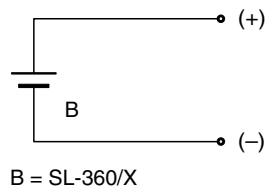
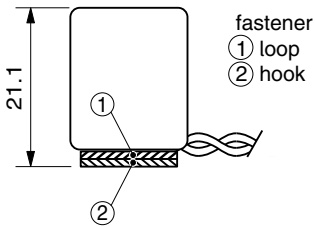

Available Capacity

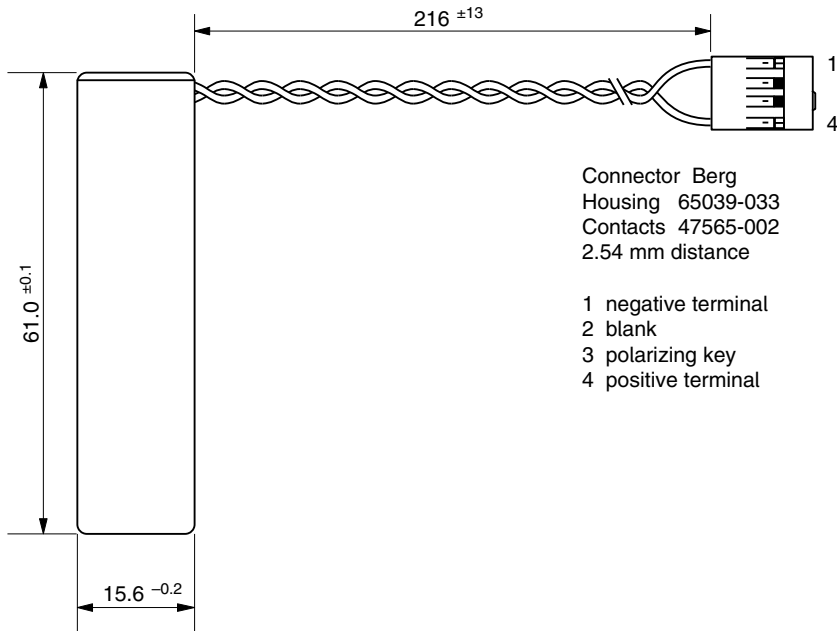
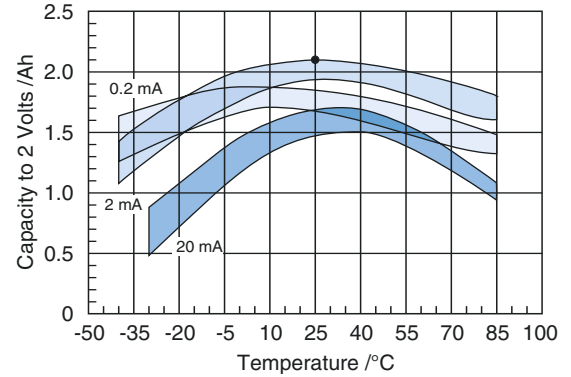

Operating Voltage

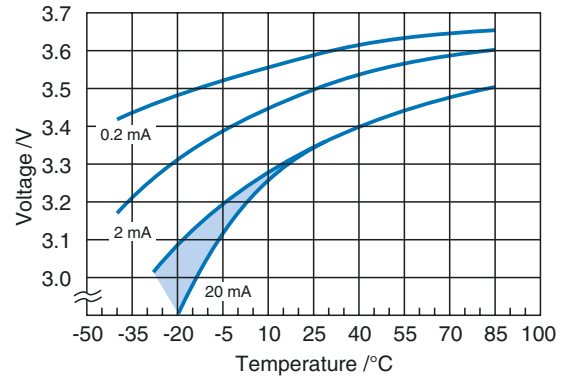

Available Terminations **Catalogue No.**

SL-360/461 Cable and connector 14 1 6360 461

Any values given here are for information purposes only. They also depend on actual conditions of use and are not warranties of future performance. Subject to change.



Keyword:
Computer Battery

Type: SL-360/486

Performance Data

(Typical values for batteries stored at 25°C for one year)

System	Li/SOCl ₂
Nominal voltage	6.0 V
Nominal capacity	1.9 Ah
Nominal current	0.2 mA
Max. continuous discharge current	0.2 mA
Wires	AWG 24
Housing	UL 94V2
Classification	user replaceable
Weight	60 g
Temperature range	-55...+85 °C

WARNING:
Fire, explosion, and severe burn hazard. Do not recharge, disassemble, heat above 100 °C, incinerate, or expose contents to water.

See page 4 for further safety recommendations.

Typical Discharge Curves at +25°C

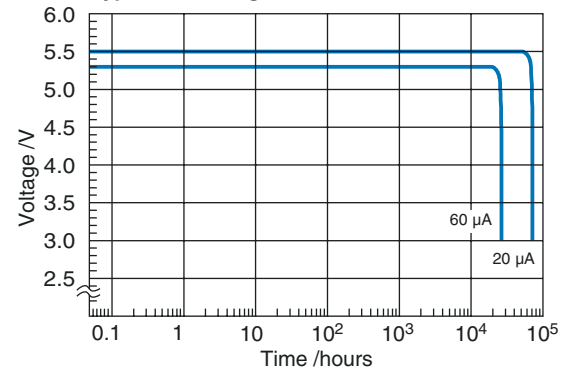

SL-360/486

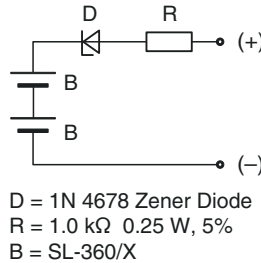
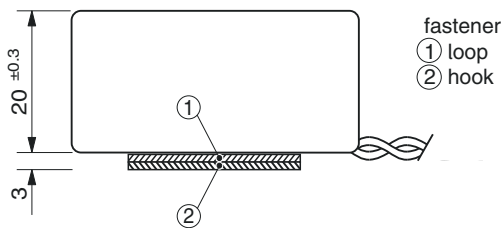

Available Capacity

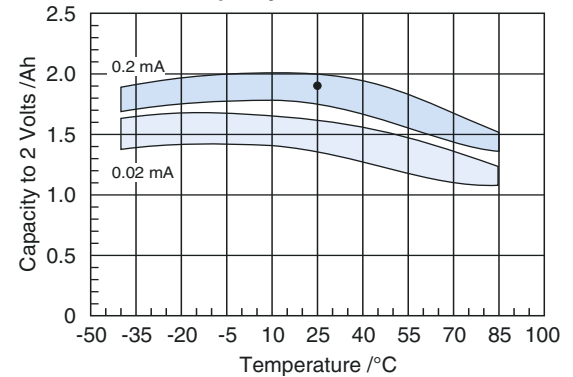

Operating Voltage

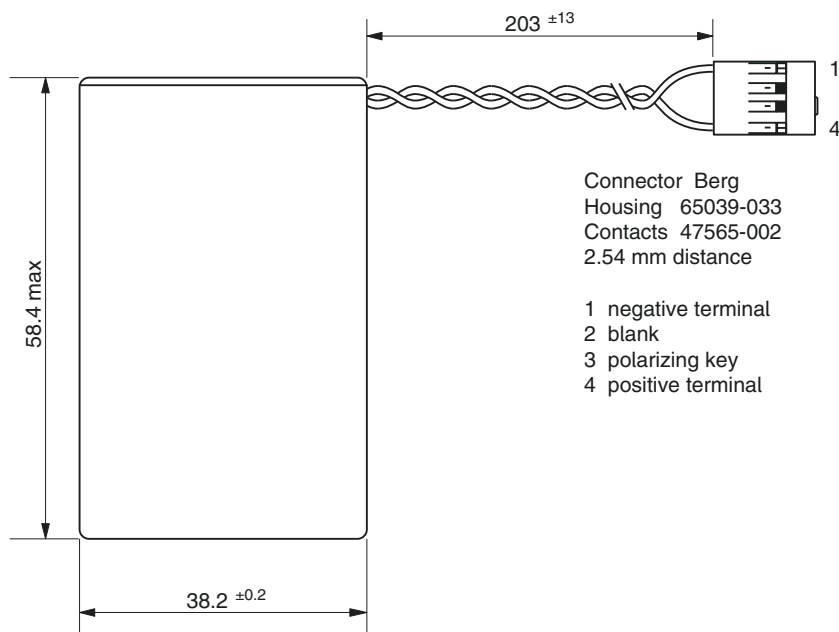
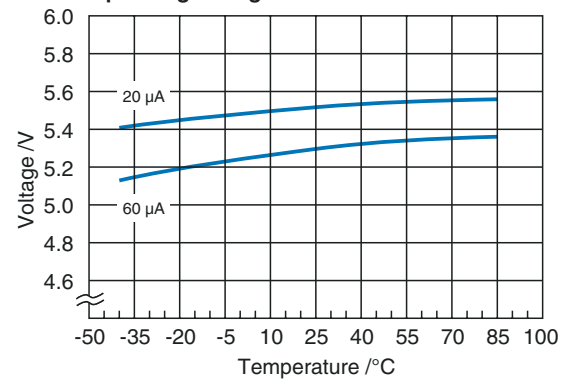

Available Terminations

SL-360/486 Cable and connector

Catalogue No.

14 2 6360 486

Any values given here are for information purposes only. They also depend on actual conditions of use and are not warranties of future performance. Subject to change.

Transport Regulations

Sonnenschein Lithium
Product Data Catalogue

Lithium Batteries are dangerous goods, UN 3090. Therefore they are generally subject to transport regulations depending on the transport mode. The **table** on this page gives a brief summary.

However, Sonnenschein Lithium Batteries in this catalogue having not more capacity than 3 AA cells are exempted from dangerous goods regulations because they meet the provisions listed hereafter:

- Cells contain no more than 1 g of lithium.
- Batteries contain no more than 2 g of lithium.

■ They have passed the tests required by the UN manual of tests and criteria. Therefore special provision 188 applies and they are not subject to the regulations, provided the following general rules are observed:

- Batteries are separated from each other in the packaging so as to prevent shorting.
- Batteries are packed in strong outside packaging (except when installed in electronic devices) with a gross weight not exceeding 30 kg per package.

- Each package is capable of withstanding a 1.2 m drop test in any orientation without damage to cells or batteries contained therein, without shifting of the contents so as to allow battery to battery (or cell to cell) contact and without release of contents; and
- The package and the shipping documents are marked with a notice indicating that it contains lithium batteries and shall - if damaged - be quarantined, inspected and repacked.

A Technical notice with more detailed information is available upon request.

Transport regulations for restricted types (other than exempted)					
Class	Limitations and Instructions	Passenger aircraft IATA DGR	Cargo aircraft IATA DGR	Road/ Railway transport ADR/RID	Sea transport IMDG Code
Lithium batteries					
UN 3090, class 9	Maximum gross mass per package Packing group Packing instruction Marking	5 kg II 903 Class 9 label	35 kg II 903 Class 9 label Handling Label For Cargo Aircraft Only	According to packaging approval II P903, P903a Class 9 label	According to packaging approval II P903 Class 9 label
Further instructions		Batteries shall be separated so as to prevent short-circuit. Batteries shall have passed the tests described in the UN Manual of tests and criteria, Part III, sub-section 38.3			
Lithium batteries contained in equipment / packed with equipment					
UN 3091, class 9	Maximum gross mass per piece of equipment Maximum gross mass per package Packing group Packing instruction Marking	5 kg / - - / 5 kg II 912 / 918 Class 9 label	5 kg / - - / 35 kg II 912 / 918 Class 9 label Handling Label For Cargo Aircraft Only	- / - - / - II P903, P903a Class 9 label	- / - - / - II P903 Class 9 label

Table

Transport regulations for Sonnenschein Lithium Batteries with more than 2 g lithium content.

It is necessary to refer to the listed regulations and instructions for detailed information. They are reviewed on a regular basis. The table is based on the 2003 revisions.

The applicable documents are:

ADR: European Agreement concerning the International Carriage of Dangerous Goods by Road,
IATA DGR: International Air Transport Association, Dangerous Goods Regulations
ICAO: International Civil Aviation Organization, Technical Instructions for the Safe Transport of Dangerous Goods by Air.

IMDG Code: International Maritime Dangerous Goods Code
RID: International Statutory Order on the Conveyance of Dangerous Goods by Rail
UN: United Nations Recommendations on the Transport of Dangerous Goods, Manual of Tests and Criteria

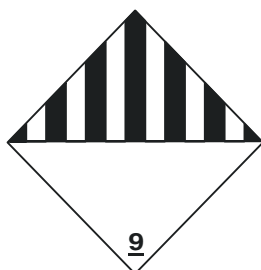









Class 9 label,
reduced size,
black on white

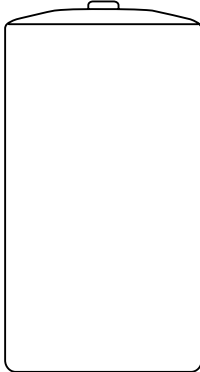
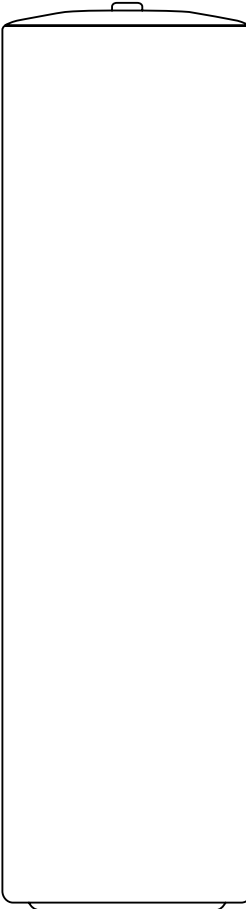

Handling Label for
Cargo Aircraft Only,
reduced size,
black on orange

Sonnenschein Lithium Batteries

 <p>BEL SL-340 p. 6 SL-740 p. 15</p>	 <p>1/10D SL-389 p. 7 SL-789 p. 16</p>	 <p>1/6D SL-386 p. 8 SL-786 p. 17</p>
 <p>1/2AA SL-350 p. 9 SL-550 p. 12 SL-750 p. 18</p>	 <p>C SL-770 p. 21</p>	 <p>DD SL-790 p. 23</p>
 <p>2/3AA SL-361 p. 10 SL-561 p. 13 SL-761 p. 19</p>	 <p>D SL-780 p. 22</p>	
 <p>AA SL-360 p. 11 SL-560 p. 14 SL-760 p. 20</p>		